

# MAQA

User Manual



Fleet (Line Markers) Limited Fleet House, Spring Lane, Malvern, Worcestershire, WR14 1AT

Tel: + 44 (0) 1684 573535

[www.fleetlinemarkers.com](http://www.fleetlinemarkers.com)

[sales@flmuk.com](mailto:sales@flmuk.com)

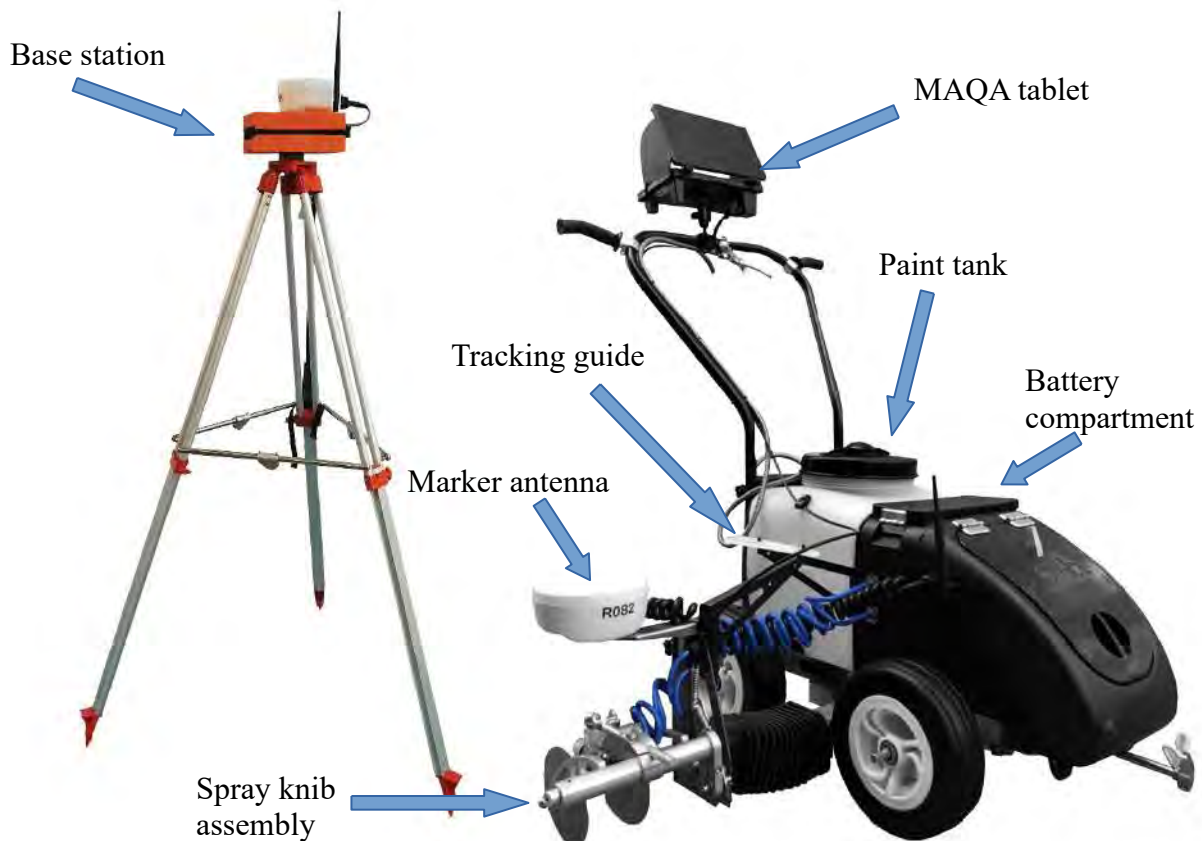

## Managers responsibility

The MAQA manager has certain responsibilities and duties to perform, to ensure the MAQA, is used to its full capability and cost effectiveness. These tasks are listed below.

1. It is the responsibility of the MAQA manager, to ensure that marking data is uploaded on a monthly basis, using the software provided (MAQA Synchroniser). The user will be sent details, enabling them to log into [www.maqamarker.com](http://www.maqamarker.com), as well as the MAQA synchroniser. The MAQA synchroniser installer, can be found on the 'Downloads' page of [www.maqamarker.com](http://www.maqamarker.com).
2. The management system also provides other management functionality which the user may or may not choose to take advantage of, including:
  - a) Customer management
  - b) Location management
  - c) Employee data with access to usage and productivity information.

## **Operators responsibility**

The grounds staff are responsible for line marking using the MAQA Marker and base station. To get the best operational performance they should.

1. Using the MAQA equipment in a safe manner and in accordance with the instructions given in the user manual.
2. Cleaning and flushing the MAQA equipment in accordance with the instructions given in the user manual.

## **WARNINGS and CAUTIONS**

1. **RISK OF BURNS. DO NOT SHORT CIRCUIT THE BATTERY TERMINALS.**
2. **RISK OF EXPLOSION. DO NOT ATTEMPT TO CHARGE A BATTERY, USING ANYTHING OTHER THAN CHARGING EQUIPMENT SUPPLIED BY FLEET.**
3. **HIGH HYDRAULIC PRESSURE. THE PAINT DELIVERY SYSTEM IS CAPABLE OF ATTAINING 100 PSI. ADJUST ONLY AS INSTRUCTED.**
4. **ELECTROSTATIC SENSITIVE ELECTRONIC COMPONENTS. DO NOT OPEN ANY ELECTRONIC MODULE ENCLOSURES.**

## **Batteries**

There are three rechargeable batteries that supply power for the MAQA system. Each battery must be in a charged state for the MAQA system to operate.

The Marker unit and the base station batteries are charged using the common docking station.

The batteries in the Marker and base station must be charged and discharged every month to retain their full working capacity. The batteries must not be discharged completely. When the MAQA system is not in use it is important that the batteries are discharged and recharged once a month.

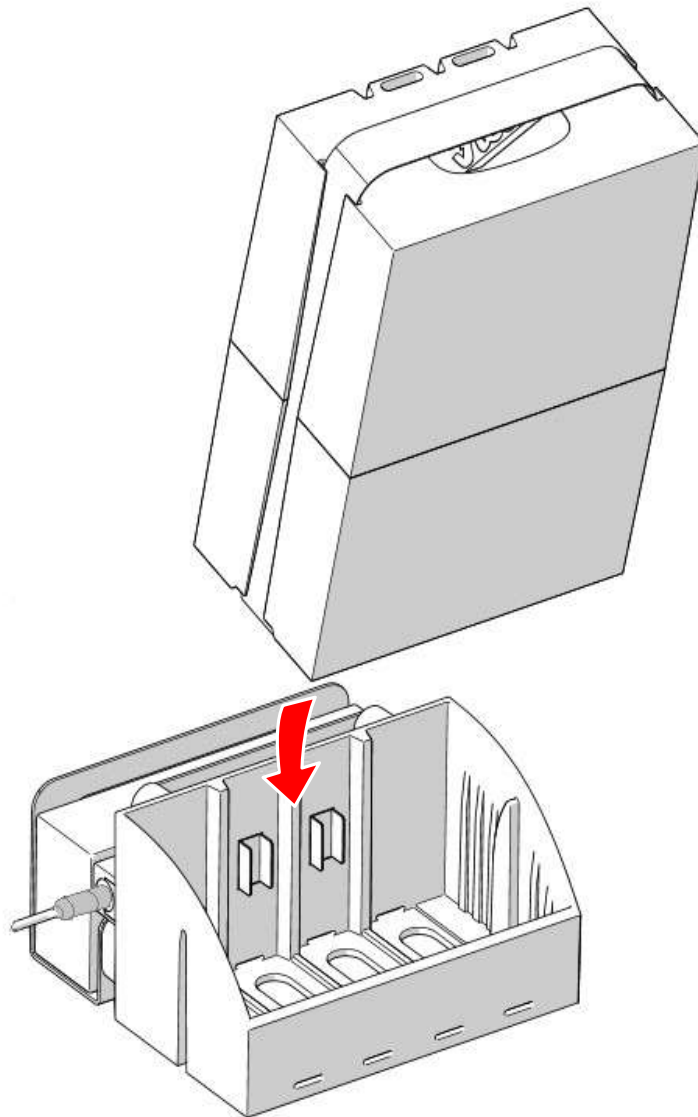

MAQA marker battery

The MAQA marker is powered by a 24 V 12Ah rechargeable battery.

The battery is fitted in the middle compartment of the Marker.

To recharge the battery, hold the webbing strap and lift it out of the docking station. Place the battery into the charging station and connect it to a suitable 230 V ac mains supply.

MAQA base station battery

The MAQA base station is powered by the integral rechargeable battery.

Battery charge state is indicated by the illuminated ON/OFF push button switch. The switch illuminated green indicates that the battery is charged and ready for use. When the switch is illuminated red, this indicates the battery charge is low.

The base station is recharged by removing the unit from the tripod and the placing the complete base station unit into the docking station.

MAQA control tablet battery

The control tablet has an inbuilt battery. It is charged via the USB connection. The tablet remains in the waterproof case during charging.

The tablet battery charge state is indicated on the status bar at the bottom right hand side of the tablet screen.



Note: This is an indication of the tablet battery level not the MAQA Marker machine.



Indication	Percentage of battery charge remaining (%)
 Battery	100 - 50
 Battery	50 - 10
 Battery	Below 10

Table. 1 Tablet battery charge indication

When the indicator shows red, shut the MAQA system down as soon as convenient and recharge before reusing the MAQA

When the battery charge is below 10 % the ability to control the marking arm may be lost.

To charge the tablet battery, proceed as follows:

1. Disconnect the waterproof USB connector on the 'leg' of the tablet case.
2. If necessary, remove the tablet case from the handle bar mount.
3. Connect the USB A male connector to the waterproof socket

- 4. Using the toggle switch located on the inside surface of the tablet 'leg', select the 'charge' position

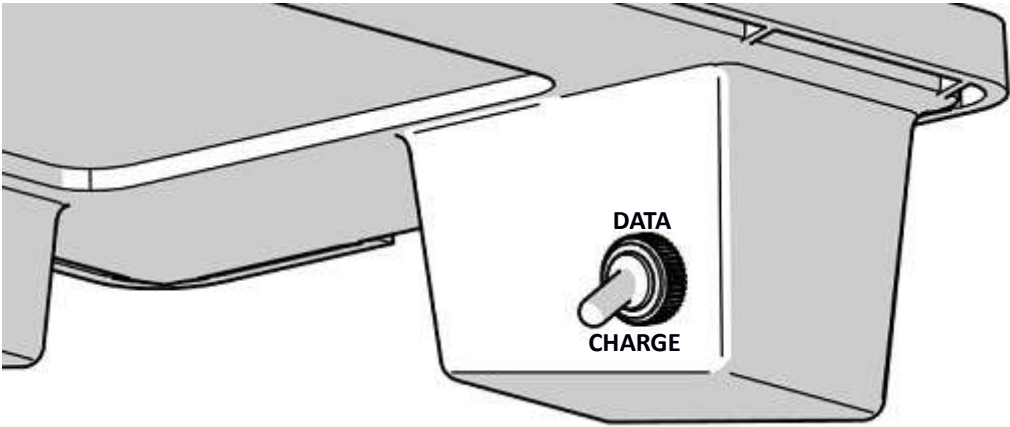

## Preparation for use

Before line marking can commence, the following procedures must be carried out.

### Base station

1. The base station has to be set up on its tripod in a location that has clear line of sight to all areas to be marked.
2. If multiple pitches are to be marked, the location of the base station is to be as central as possible to all the pitches.

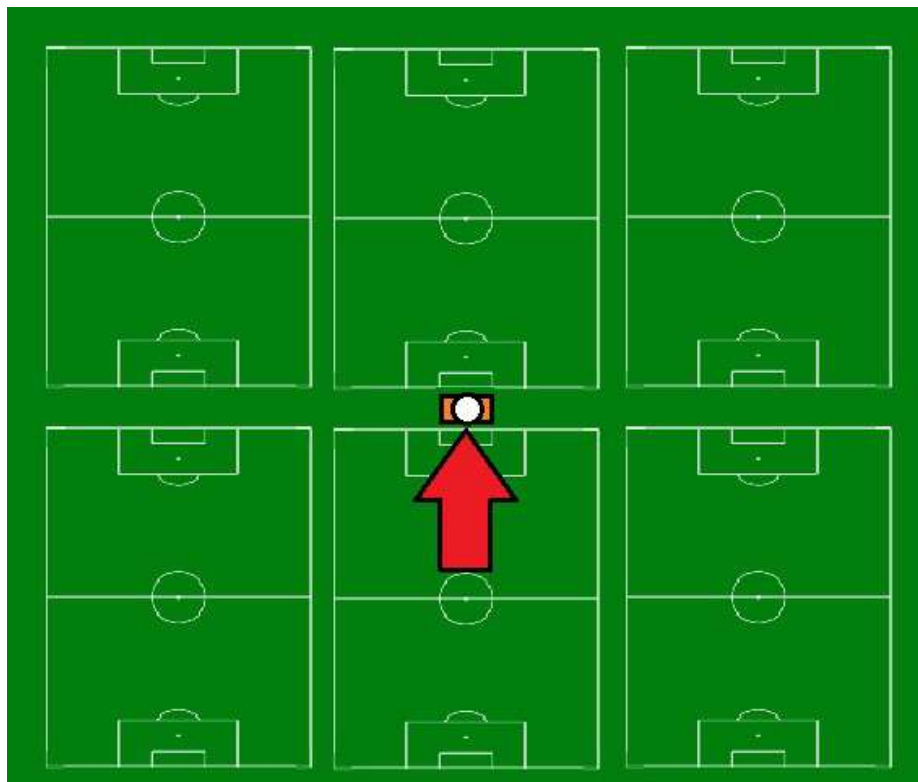

3. The range of the base station with clear line of sight is up to 500m. This range will vary due to local conditions i.e. obstructions, interference.
4. Switch the base station ON using the push button switch. The push button illuminates GREEN indicating that the battery is charged. When the button illuminates RED, this indicates that the battery has low charge. If the indicator shows red during a line marking session, it is recommended that the system should be shut down when the current pitch has been completed.
5. The MAQA base station will take approximately 15 minutes to acquire satellites to establish positional data.
  - a) Do not move the base station during this time or any other time during the line marking session.







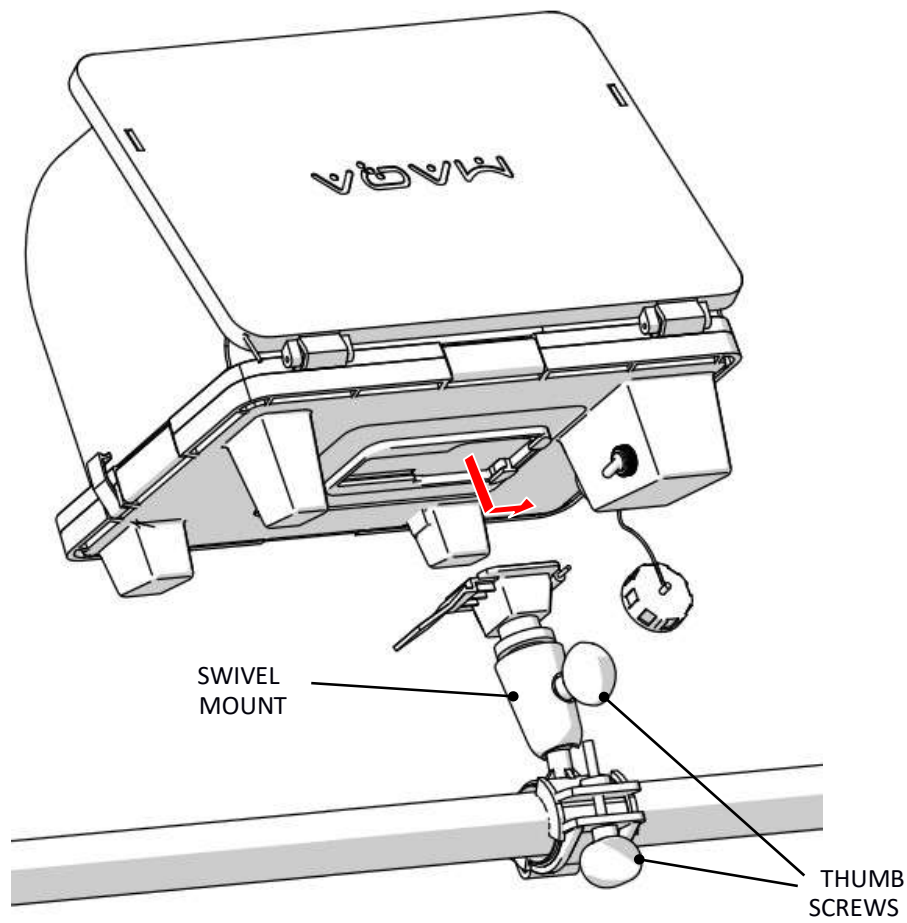

2. Lift up the screen cover.
3. Unfold the two side shades and slot the tabs into the slots on the top surface of the tablet case.
4. Secure the side screens using the two clips.

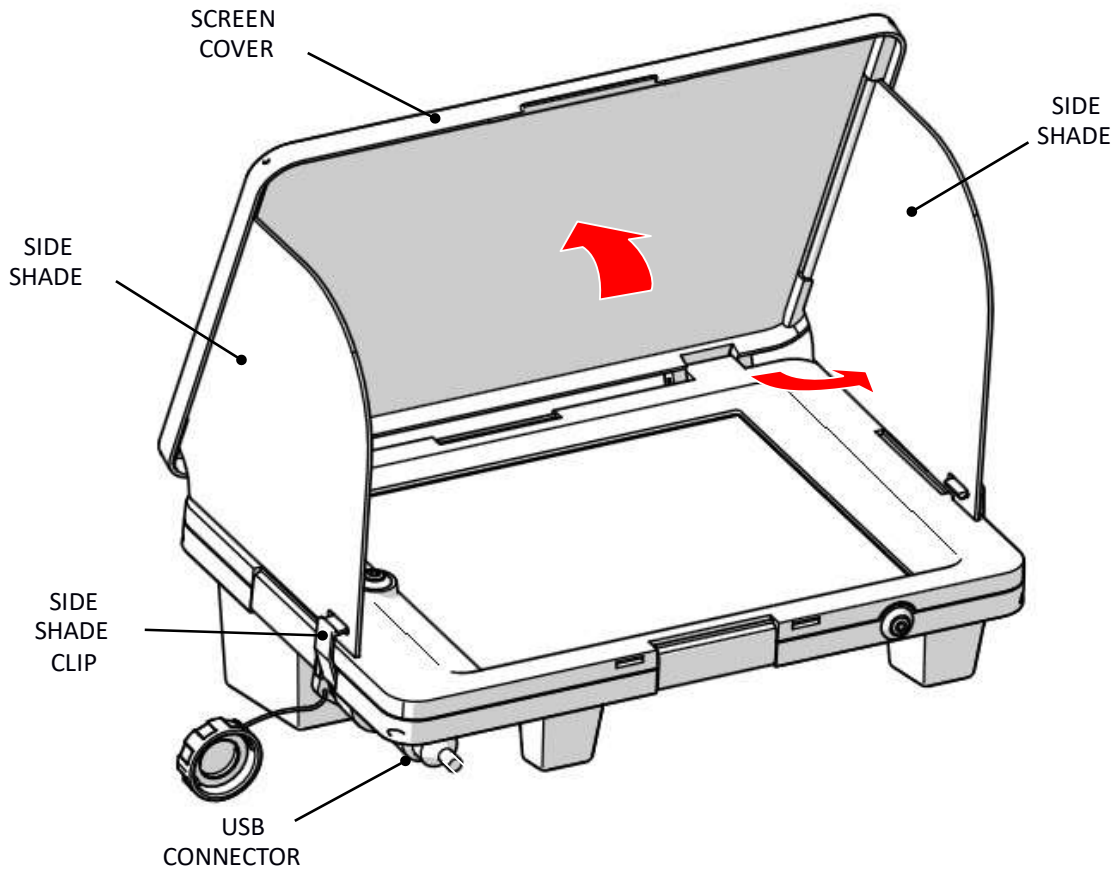
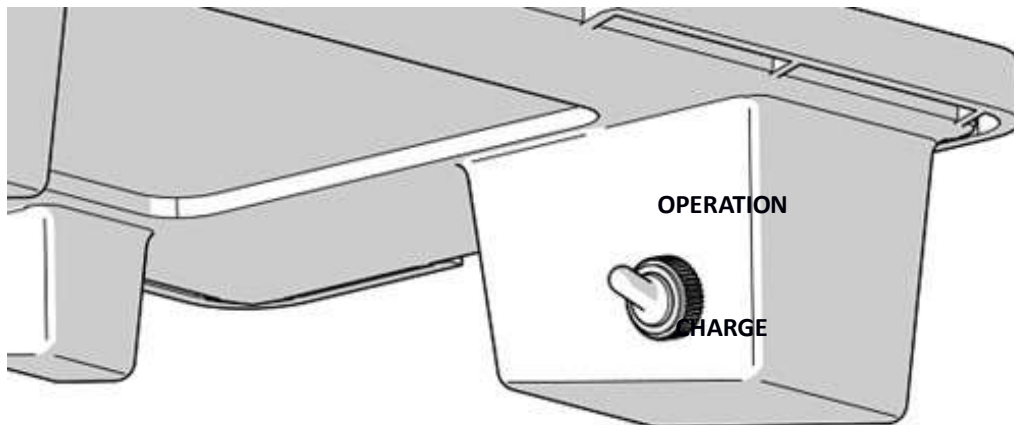

Fig. 8 Tablet case

5. Ensure that the USB cable assembly is securely fitted into the connector on the 'leg' of the tablet case.
6. Ensure that the toggle switch located on the 'leg' of the tablet case is in the 'OPERATION' position before turning the tablet on.



## Initialising the MAQA tablet software

The MAQA tablet controls all aspects of the line marking.

Note: The tablet is operated by touch screen. The touch screen technology will not function using a gloved hand. Specialized gloves with touch screen pads may be used.

1. Turn the tablet ON by briefly pressing the rubberised button on the front edge tablet case. Please ensure tablet is in operation mode before using it with MAQA, if turned on while in charge mode please switch tablet to operation mode and restart the tablet.
2. The MAQA software will initialise. The 'MAQA' logo will fill the screen. A MAQA button will appear in the centre of the screen. Tap the 'MAQA' button.
3. A prompt to enter the Tablet Pin code that is supplied with the licence. Enter the code.



4. The blue Fleet Line Markers screen appears requesting 'User name' and 'Password'.
5. Enter the authorised 'User name' and 'Password'
  - a) If incorrect details have been entered, a failed dialogue message appears.
  - b) When the correct information is entered, authentication takes place, this indicates the login has been successful.
  - c) All pitches that have been marked using the using the tablet will be stored for future use.
6. Following a successful login, the main home screen will appear.







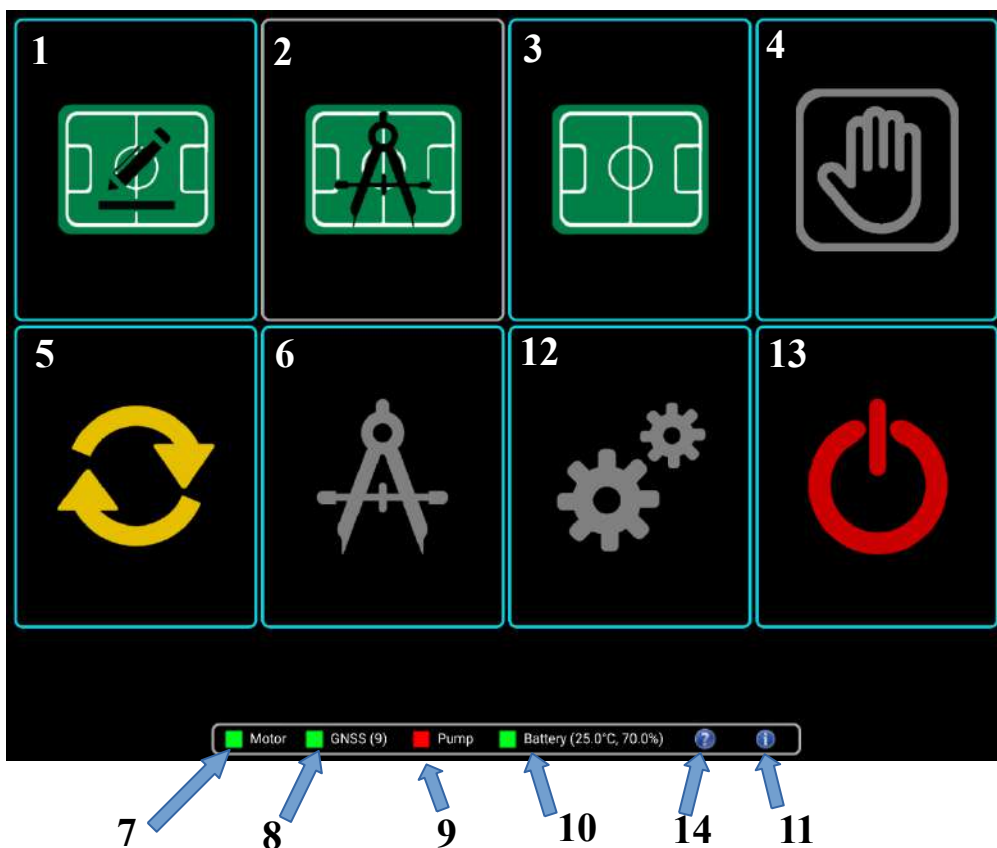



Note: When the MAQA application is closed, the login screen returns. If required, another user can login with a different username and password.



All functions are made from the home screen. The functions comprise the following groups.

1. Four line marking options.
2. Three system tools.
3. Status indicators.
4. A 'Log out' button



1	Create a new pitch	8	GNSS (Number of acquired satellites)
2	Pitch designer	9	Pump control status
3	Remark a pitch	10	Tablet battery charge indicator
4	Manual marking	11	System information
5	Synchronise to management system	12	Settings
6	Calibration	13	Log out/ Shutdown
7	Actuator motor control status	14	Tutorial videos

Serial	Icon	Legend	Function
1		-	Select this icon to create a new pitch on unmarked ground.
2		-	Pitch designer icon. This feature is under development and is not yet available.
3		-	Select this icon to remark pitch that has been previously marked from either creating or uploading a pitch design. The pitch data is recorded and will be available for reuse.
4		-	Select this icon to use the MAQA in manual mode to line mark.
5		-	Select this icon to synchronise to the management system. This facility is used to send line marking data to the MAQA management system and to download software updates.
6		-	Select this icon to recalibrate the actuator arm.
7		Motor	Actuator arm motor communication status. Green - connectivity with tablet. Red - no connection
8		GNSS	GNSS Global Navigation Satellite System. The number of satellites acquired are shown in brackets. Green –High accuracy (approximately +/- 1cm) Amber –Poor accuracy (typically +/-10cm) Red – Position calculated by the Marker unit alone (i.e. without the base station), and represents very poor accuracy (typically +/-1m) Do not attempt to mark a line.
9		Pump	Paint spraying pump communication status. Green – Pump ON. Red – Pump OFF
10		Battery	Tablet battery charge status. Green – 100 -50% charge remaining Amber – 50 -10% charge remaining Red – Less than10% charge remaining.
11		-	Information. Selecting this icon will display information about the MAQA. The software version, disc space and licence details (days remaining until sync is required) will be shown.

12		-	<p>Information. Selecting this icon will display information about the MAQA. The software version, disc space and licence details (days remaining until sync is required) will be shown.</p>
13		-	<p>Shut down and power OFF. Select this icon to close the MAQA application.</p>
14		-	<p>Tutorial videos has helpful videos explaining how to use the MAQA tablet.</p>

## Creating a new pitch



To create a new pitch, select this icon from the main home screen. Choose this option when marking a pitch in a new location. The 'Create a new pitch start screen' is displayed.

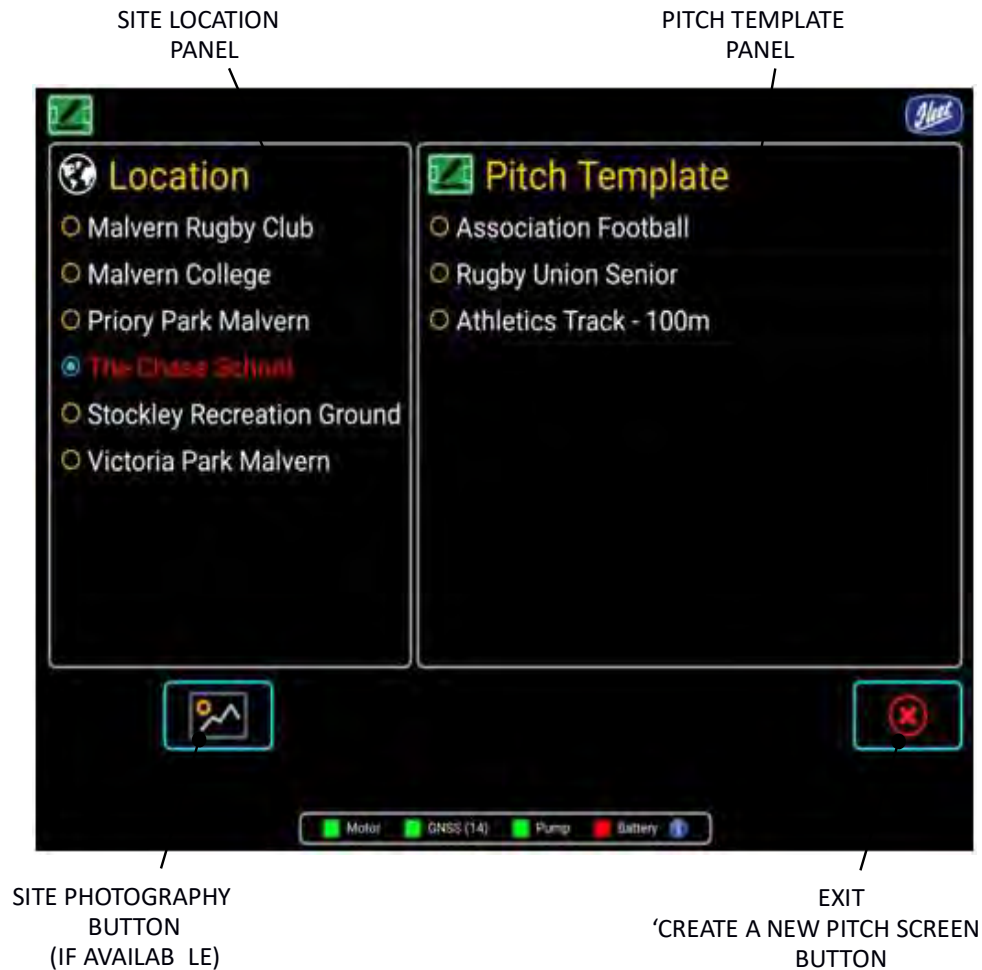

The left hand panel shows sites that are stored in the MAQA.

The right hand panel gives a list of pitch templates available. The selected item is denoted by red text.

If photographs of the location have been loaded, they can be displayed by selecting the Site Photography button.





Note: Note that a pitch name has to be at least 6 characters long, contain only alphanumeric characters, and must be unique (i.e. 2 pitches cannot be called “Football123”).

Select the green tick to continue and create the field, or the red X to exit this dialogue box.

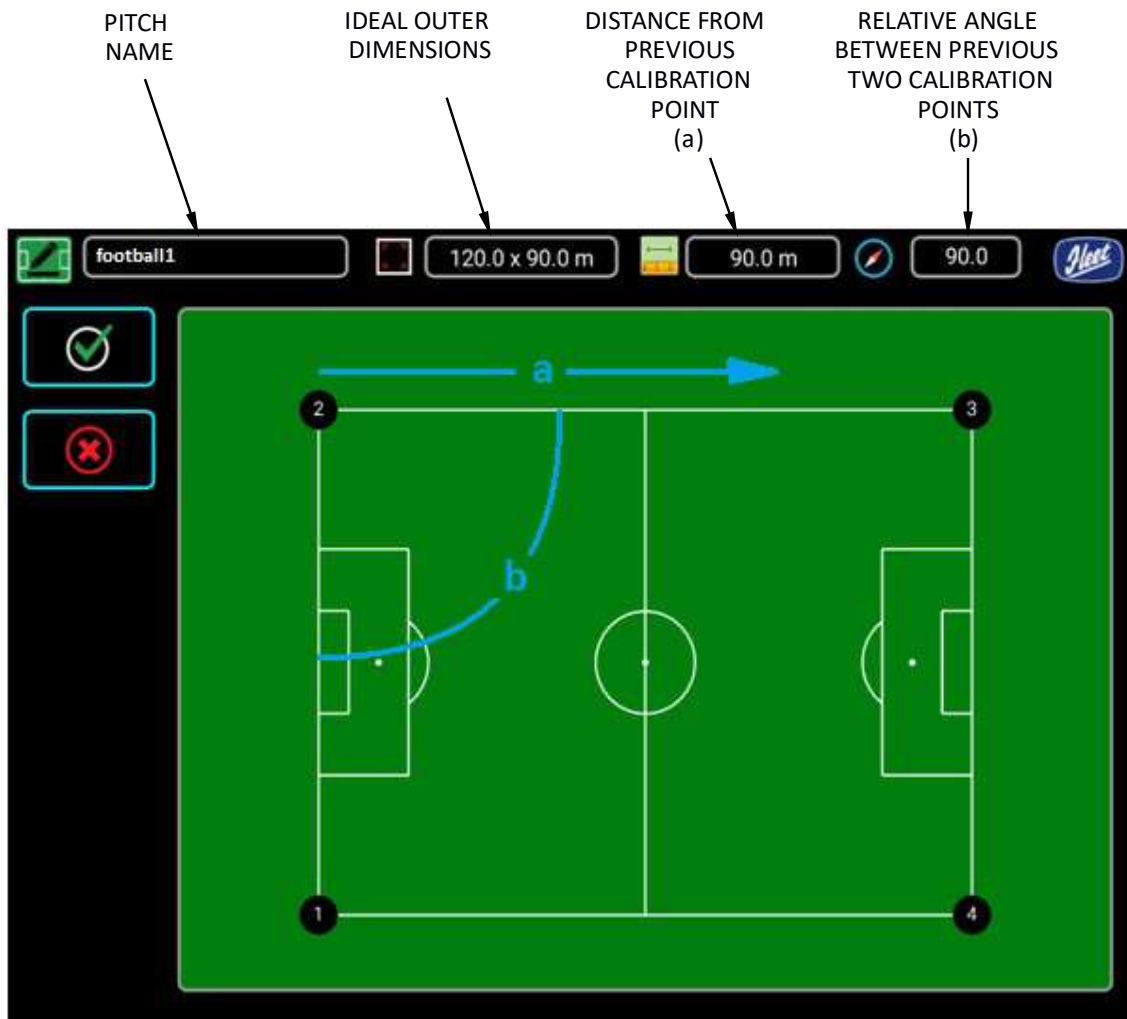

## Calibrating a new pitch

Calibration defines the size, orientation and skew of the pitch. In order to calibrate a new pitch, the MAQA requires calibration locations. The calibration locations are referred to as ‘points’ and are shown on screen as ❶❷❸❹.

### New pitch – no existing goal posts

MAQA will calibrate to mark a new pitch with only 1, 2 and 3 points located. This produces a perfectly ‘square’ pitch with parallel sides and 90 degree corners. The calibrate a new pitch, proceed as follows:

1. Position the marking knib of the MAQA directly over the starting point (Point ❶). This point is determined by the user.

## MAQA User Manual

2. Tap **1** on the screen. This will record the position. This is denoted by the symbol changing colour to red **1**.
3. With reference to the distance and angle information displayed at the top of the screen, push the MAQA to locate the next point. When the knib is directly over the specified point (distance/angle), tap **2**. The points are to be recorded in numerical order, 1-2-3.
4. The recording of a point can be deleted by a second tap. The symbol will revert from red back to black **1**.
5. When all the points have been successfully recorded, select  to navigate to the Marking Screen. Selecting **X** will navigate back to the main home screen.

Note: If points **1 2 3** have been recorded, then it is decided that point **2** has been recorded in the wrong position and is deleted, point three will also be deleted **1 2 3**. Points two and three will have to be recorded again.

Note: If the user attempts to navigate to the next screen without recording at least 3 points the software will alert the user.

### New pitch – existing goal posts

If a site has existing goal posts that are to remain in place, the MAQA will require all 4 points because the goal post cannot be guaranteed to be parallel with each other.

Note: If the existing goal posts are not parallel, the MAQA software will compensate and adjust all the other lines of the pitch accordingly.

1. A laser device or string line must be used to establish a base line using the existing goal posts as a datum. Measure from the centre point between the goal posts half the distance of the desired pitch width. Mark this position with a peg. This position is point **1**.
2. Establish a datum for the other goal line, Measure from the centre point between the goal posts half the distance of the desired pitch width. Mark this position with a peg. This position is point **3**



3. Position the marking knib of the MAQA directly over the starting point (Point ❶). Tap ❶ on the screen. This will record the position. This is denoted by the symbol changing colour to red ❶.
4. With reference to the distance information displayed at the top of the screen, push the MAQA along the datum line to locate the next point ❷. When the knib is directly over the specified point (distance/on datum line), tap ❷. The points are to be recorded in numerical order, 1-2-3-4.
5. Push the MAQA to point ❸ (marked with a peg on the datum line). Record this position.
6. Push the MAQA along the datum line and with reference to the distance information locate point ❹ on the datum line.
7. The recording of a point can be deleted by a second tap. The symbol will revert to black ❶.
8. When all the points have been successfully recorded select, ✓ to navigate to the Marking Screen. Selecting X will navigate back to the main home screen.



Note: If points ❶ ❷ ❸ have been recorded, then it is decided that point ❷ has been recorded in the wrong position and is deleted, point three will also be deleted ❶ ❷ ❸. Points two and three will have to be recorded again.

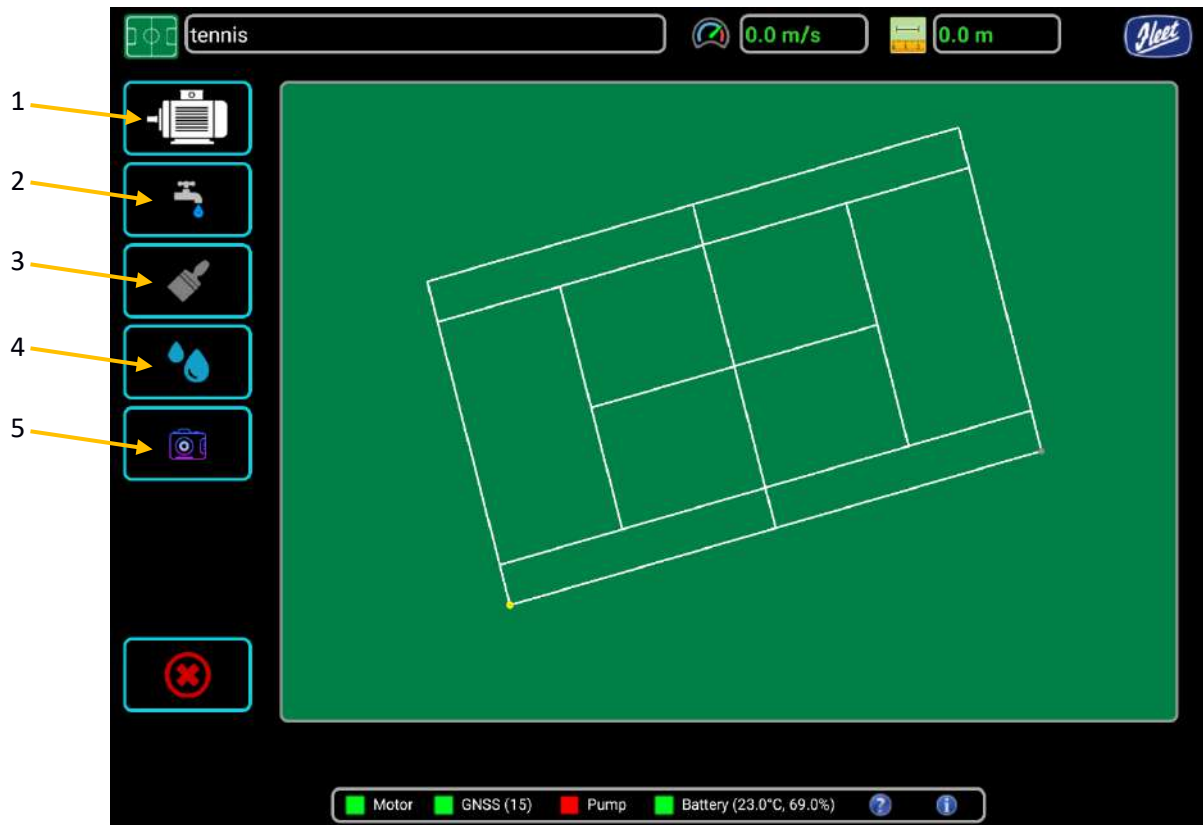

## Marking the lines

Marking lines on the field are controlled with the use of the Marking screen.



Note: The pitch on the Marking screen is always orientated North Up. The example show is aligned with the goal lines approximately north/south. Pitches for different locations will vary.

Serial	Button icon	Function
1		Pump override – This button overrides the computer control of the paint spraying pump. First tap = Turns the spray pump OFF Second tap = Returns the spray pump to computer control. As it is in computer control, the pump will only spray when the knib is over a line to be marked.
2		Nozzle flush – This button toggles the water pump between ON and OFF.
3		Manual Mark without GNSS- This feature is not yet available. This button in the future will allow you to manual mark without exiting the GNSS marking mode.

4		<p>Bleed mode- this button will re circulate the paint back into the paint tank. This function is used for mixing paint and clearing any air locks that occur in the plumbing.</p>
5		<p>Screenshot- in the event a user experiences an issue with a template they can push the screenshot button. This will store a screenshot on the users tablet and when the user next syncs to the management system the screenshot will be uploaded. This allows MAQA support to view the issue the user has experienced.</p>

### Marking lines

1. Turn the MAQA Marker master switch to the ON position. The motor, GNSS and battery indicators at the bottom of the screen should be in the green condition. This shows that the actuator motor is in communication with the tablet, sufficient satellites have been acquired and that the tablet battery is charged. Do not attempt to mark a line unless these three indicators are showing green. The pump indicator remains red until marking commences.
2. Using the touch screen, select the line that is to be marked. When the selection has been made, the line colour will change from white to red, the active line.
3. A yellow dot shows the position of the MAQA line marking knib. To deselect the active line, tap anywhere on the background.
4. When a line is selected a blue triangle symbols will appear on the screen. This is the ‘feed-in’ triangle.
5. Position the MAQA Marker so it is physically aligned with the line to be marked. Viewing the screen, move the Marker so that the yellow dot enters the blue triangle. Continue to search within the blue triangle until the actuator starts tracking the line. The blue triangle represents an area of approximately 1 meter on the ground, the range of the actuator is 20 cm.
6. When the knib is over the line to be marked the paint will start flowing, start walking at a moderate pace, approximately 2 MPH (1 m/s).
  - a) The distance remaining to be marked for the active line is shown at the top of the screen. An audible warning is emitted near the end of the line to give warning to slow down and to prevent ‘overshooting’ the end of the line.
  - b) When a line is completed the line on the screen will change colour from red to black.
7. Select the next line. When selecting the next line consider if the wheels of the MAQA Marker will cross the wet paint of the line that has been previously marked. As the knib is on the right hand side of the Marker, it is recommended that the pitch is marked clockwise. MAQA will mark all circles and arcs are marked clockwise by default.

## MAQA User Manual

Note: The tablet has zoom function, use two fingers to zoom in or out. Double tapping the screen will zoom in to the maximum magnification. A second double tap will zoom out to the normal setting.

Note: If the line is small, the user may need to 'zoom in' to select it.

Note: Deselecting a line whilst marking will turn off the pump and stop tracking.

Note: Be prepared to start walking as soon as the knib is over the line to be marked. The pump will be energized and paint will flow when the knib is over the line. Ensure that the pump override is not enabled.

### Dashed lines

The MAQA recognises the complete line not just the painted sections. A dashed line has to be lined up from the base line where the Feed in Triangle is to be engaged.

Note: MAQA automatically switches the pump ON and OFF to produce the dashed line. It is important to walk at the same steady pace as for other lines. If the walking speed is too quick, the dashed line will not be correctly spaced. For example, marking starting late and/or overrunning.



## Remarking a pitch



Select the Re-marking icon from the main home screen to view pitches that have been previously marked from either creating or uploading a pitch design. The pitch data is recorded and can be used again.

The Re-marking start screen displays list of locations that have previously been used by MAQA. Select the required location.



When a location has been selected, the Pitch panel is populated with the pitches that have been previously been marked in that location.

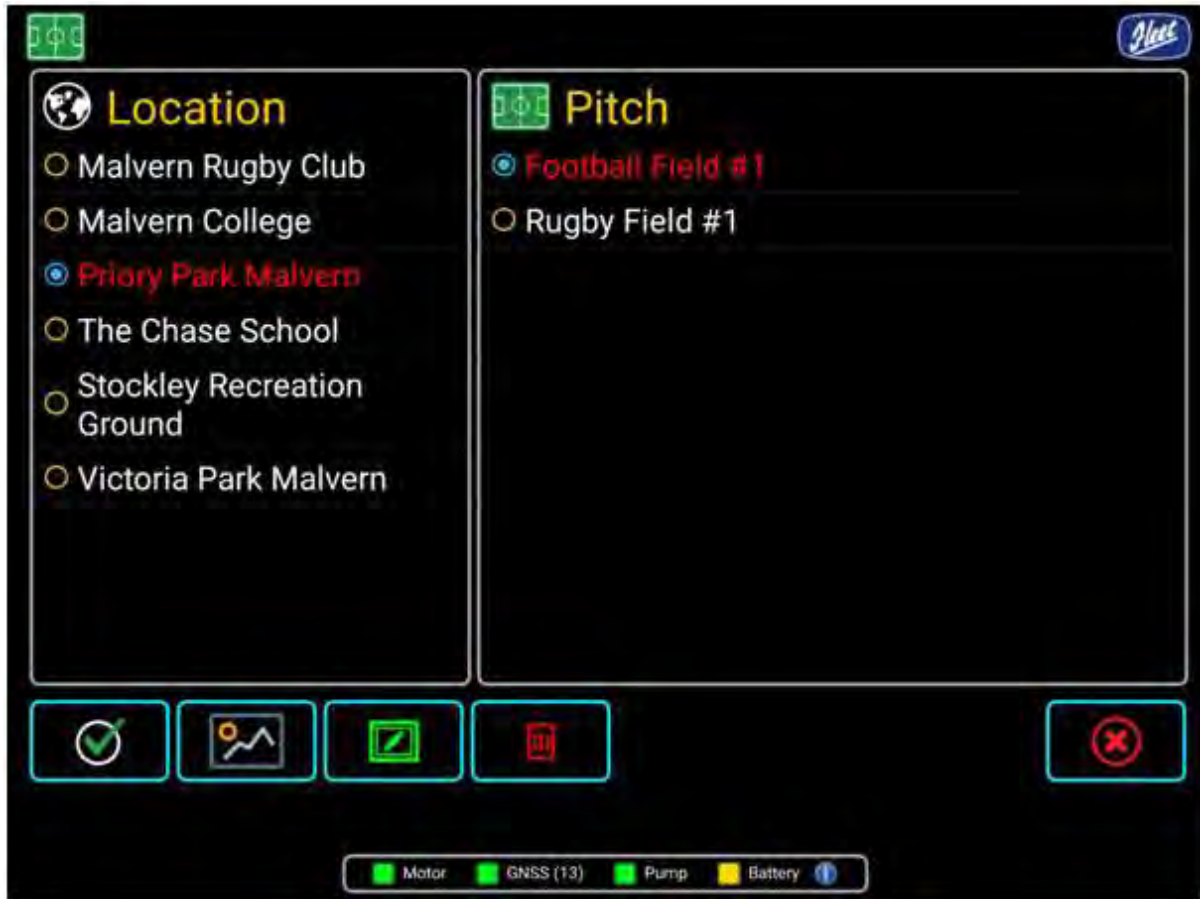

The text of selections change colour to red.

There are further options on this screen

Serial	Button icon	Function
1		Photographs – This button gives access to any photographs that have been previously loaded onto the MAQA system for this site.
2		Edit – Used to edit the text of the entries on the screen.
3		Delete – Used to delete pitch data from the MAQA system.

When the pitch to be remarked has been selected tap to continue. The selected pitch will be displayed. Selecting X will navigate back to the main home screen.

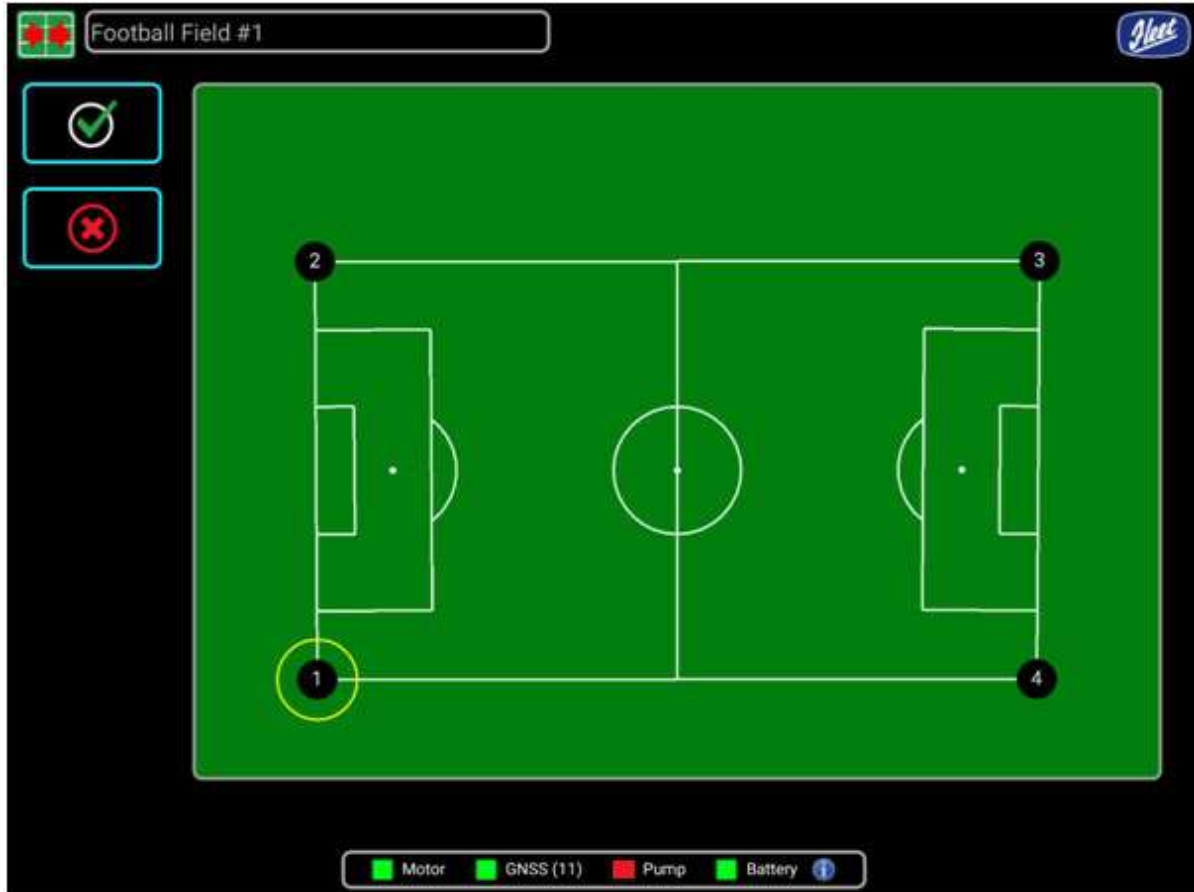





When re-marking a predefined pitch, only one point is required to be calibrated. The point to be calibrated is indicated by a yellow circle. To calibrate the MAQA to re-mark the selected pitch, proceed as follows:

1. Move the marking knib of the MAQA Marker over the point indicated on the screen.
2. When the marking knib is directly over the point indicated, tap inside the yellow circle. This calibrates the MAQA and re aligns the pitch in fine detail.

When the MAQA has been calibrated and the motor, GNSS and battery indicators at the bottom of the screen are in the green condition. Do not attempt to mark a line unless the Motor and GNSS indicators are showing green. (The pump indicator remains red until marking commences) marking can begin.

## Manual marking





Select the Manual marking icon  from the main home screen and then the green hand button . The Manual marking screen will be displayed

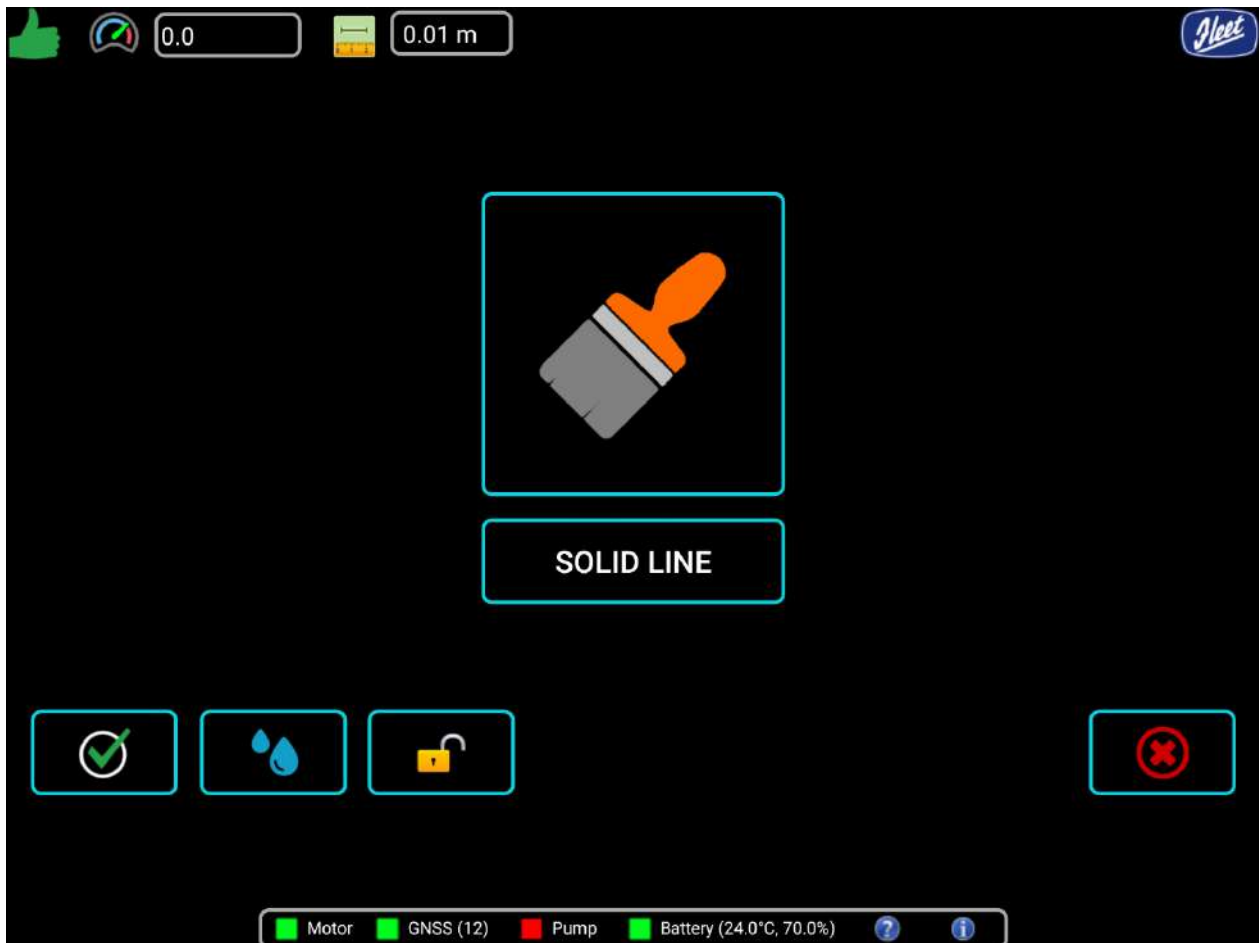

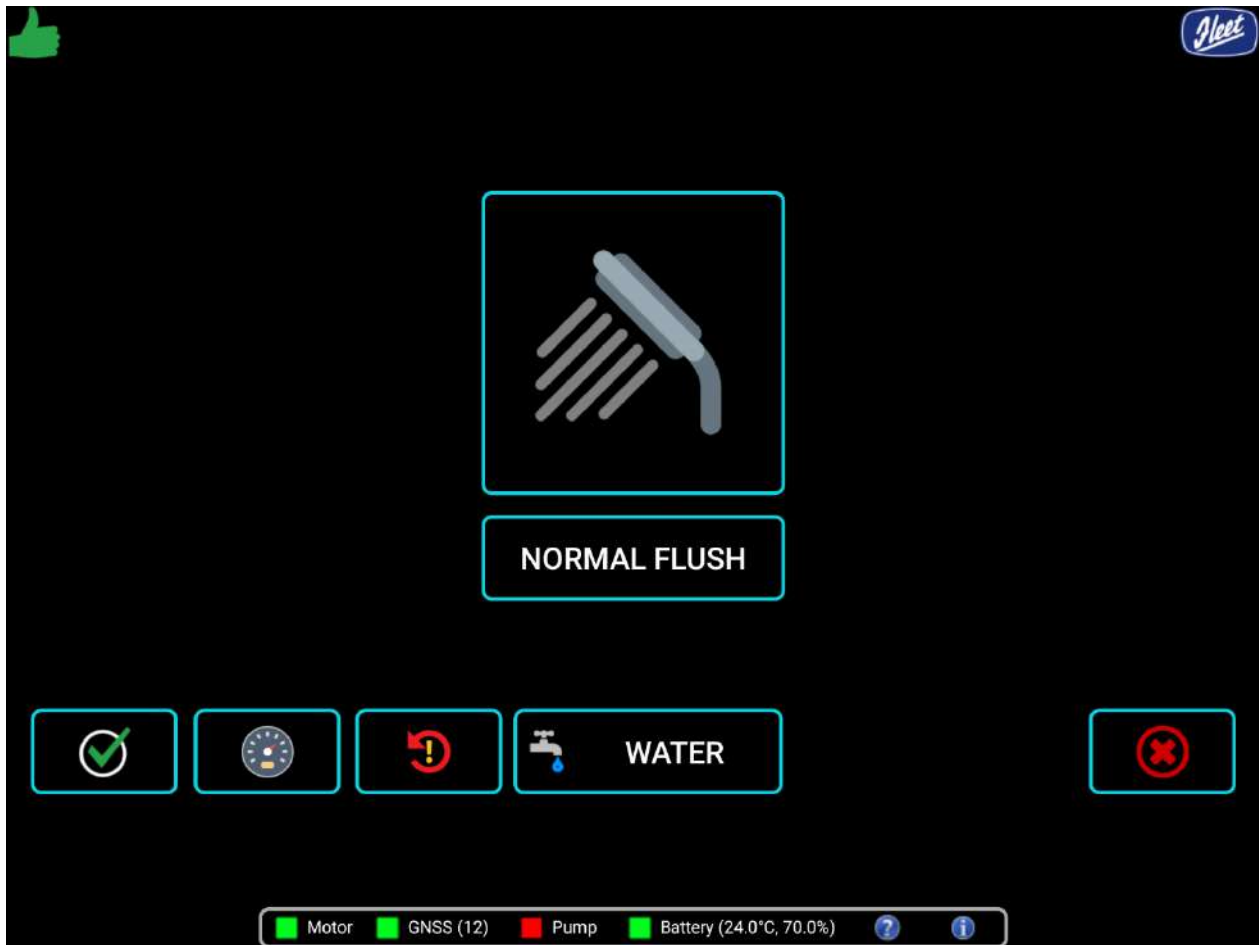
If the hand icon is selected  and then the tools icon is selected  the 'Flush' screen will be displayed.

Note: When the MAQA is used in manual marking mode, the activity data is recorded



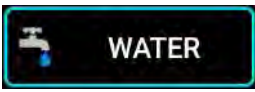

Serial	Icon	Status	Function
1		ON/OFF	Turns the paint pump ON. Line marking starts immediately. Turns the paint pump OFF. Line marking stops immediately
2		Reset GNSS	When selected the GNSS will be refreshed on the Marker unit.
3			When tapped initiates the automated flush cycle. When 'normal flush' is displayed below the shower head icon the pump draws water from the water tank at the back of the MAQA. When 'system flush' is displayed below the shower head icon the pump draws from the paint tank. (Note system flush is to be used when the paint tank has been cleaned and has clean water in)
4		Solid line	Gives optimum end of line definition when marking a solid line

5		Dashed line	Gives optimum end of line definition when marking a dashed line
6		ON/OFF	When tapped, turns the nozzle cleaning water pump ON. This button will be disabled when the paint pump is on. Used to clear the nozzle when a there is pause in line marking. When tapped, turns the nozzle cleaning water pump OFF.
7		Moving time line	Progress of flushing cycle indicator

To use the MAQA Marker in manual marking mode, proceed as follows:

1. Prepare the MAQA Marker for line marking.
2. The motor, GNSS and battery indicators at the bottom of the screen should be in the green condition. Do not attempt to mark a line unless these three indicators are showing green. The pump indicator remains red until marking commences.
3. Tap the manual marking mode button from the home screen and the green hand button to enter the manual marking screen.
4. The actuator does not move while in Manual marking mode.
5. When ready to start marking, tap the Pump ON/OFF button (brush icon). The pump will energize immediately and paint will be sprayed.
6. The speed of travel is displayed at the top right hand side of the screen.
7. The distance travelled is displayed adjacent to the speed indicator.
8. At the end of the line or when the pump is to be turned off, tap the brush icon.
9. When line marking is completed, tap the green tick or red tick to exit the manual marking screen.

Note: The MAQA cannot be operated in manual mode if there is not a GNSS signal.

Note: The manual marking mode selection button will not function while the pump is energized.

## Line marking modes

The MAQA has two line marking modes. The purpose of these modes are to give optimum 'end of line definition' for different types of line.

1. Solid – This is used when marking continuous a line. This setting is used for general line marking.
2. Dash – This setting is used when marking a dashed line (e.g. rugby pitch).

## Flushing

The MAQA is fitted with a very fine spray nozzle to give economy of paint usage. To ensure the nozzle doesn't block with dry paint, the MAQA is fitted with systems to flush the nozzle and to flush the entire paint circuit.

When marking, the nozzle is to be flushed with water at frequent intervals when the paint pump is not operational and a full flush of the entire system at the end of the day and before storage. There are multiple types of flush.



1. Nozzle only flush – Tap the  Icon on the Marking screen. This energizes the water pump which forces a small volume through only the nozzle tip to prevent paint drying in the nozzle. The button toggles between ON and OFF.
2. Complete normal flush – This function must be performed after a day's marking and before the MAQA is stored overnight or longer periods. To use the flush cycle proceed as follows;
  - a) Ensure that the water tank is full with clean water.
  - b) Position the MAQA in an area where paint contaminated water can be disposed of safely and in accordance with local regulations
3. System flush – If storing the MAQA for long time clean out main tank, fill with clean water and then perform a system flush. It is recommended you do a system flush clean once a week.
  - a) Ensure that the paint tank is full with clean water.

Note: During the flush cycle the user cannot exit this screen or use any other controls.

Note: Flush cycles are logged to the management system to ensure that the MAQA is cleaning in accordance with the contract agreement.

Note: When the WATER PUMP is operated, diluted paint will be discharged from the nozzle. Keep the duration of water pump use to a minimum to prevent unsightly marks on the pitch.



## Scalable and non-scalable templates

The templates for sports ground marking are grouped into two types, scalable and non-scalable. The scalable pitches can be tailored to fit the land that they are destined for. Many sports associations and federations give maximum and minimum sizes for the playing area. Junior pitches also have a wide range of sizes. Non-scalable templates are essential for other sports, such as athletics, where the dimensions of the markings are critical.

### Scalable template

Scalable templates include: An S before the name of the template. Example: S-protofootball

### Non-scalable template

Non-scalable templates include: An N before the name of the template. Example: N-400mtrack.

## Syncing the tablet to the Management System

The Green Sync button is present at the centre of the screen, and will be highlighted in blue when a Sync is not in progress. When the Sync is in progress the blue highlight for both the Sync button and the OK button (green tick) will be disabled, and pressing the buttons will have no effect – only when the Sync is completed or cancelled will the buttons be re-enabled.

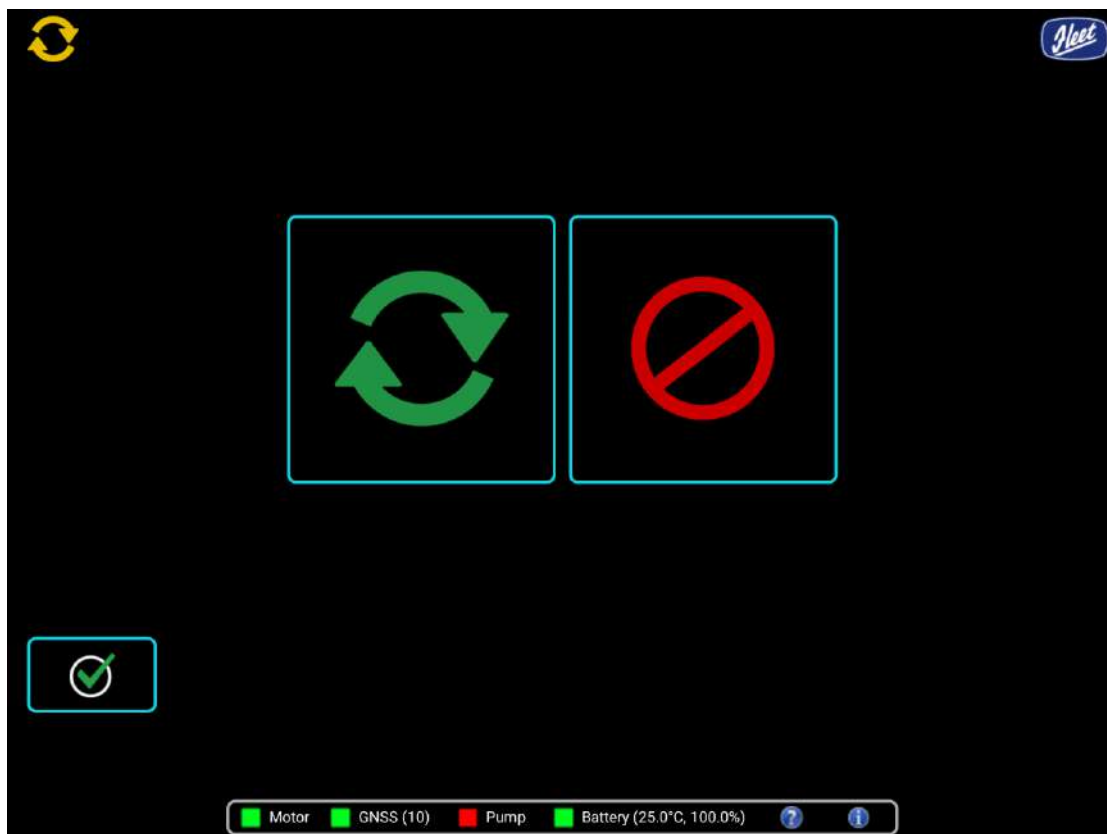

While a Sync is in progress the red Cancel button can be pressed to cancel the Sync – this will stop any Sync in progress and re-enable the OK and Sync buttons. However, this should only be undertaken if there is no other choice as this may leave the tablet in an indeterminate state requiring a full reset.

Note: Syncs may take some time to complete – when there is progress to report the progress indicator under the Sync button will update to show the progress.

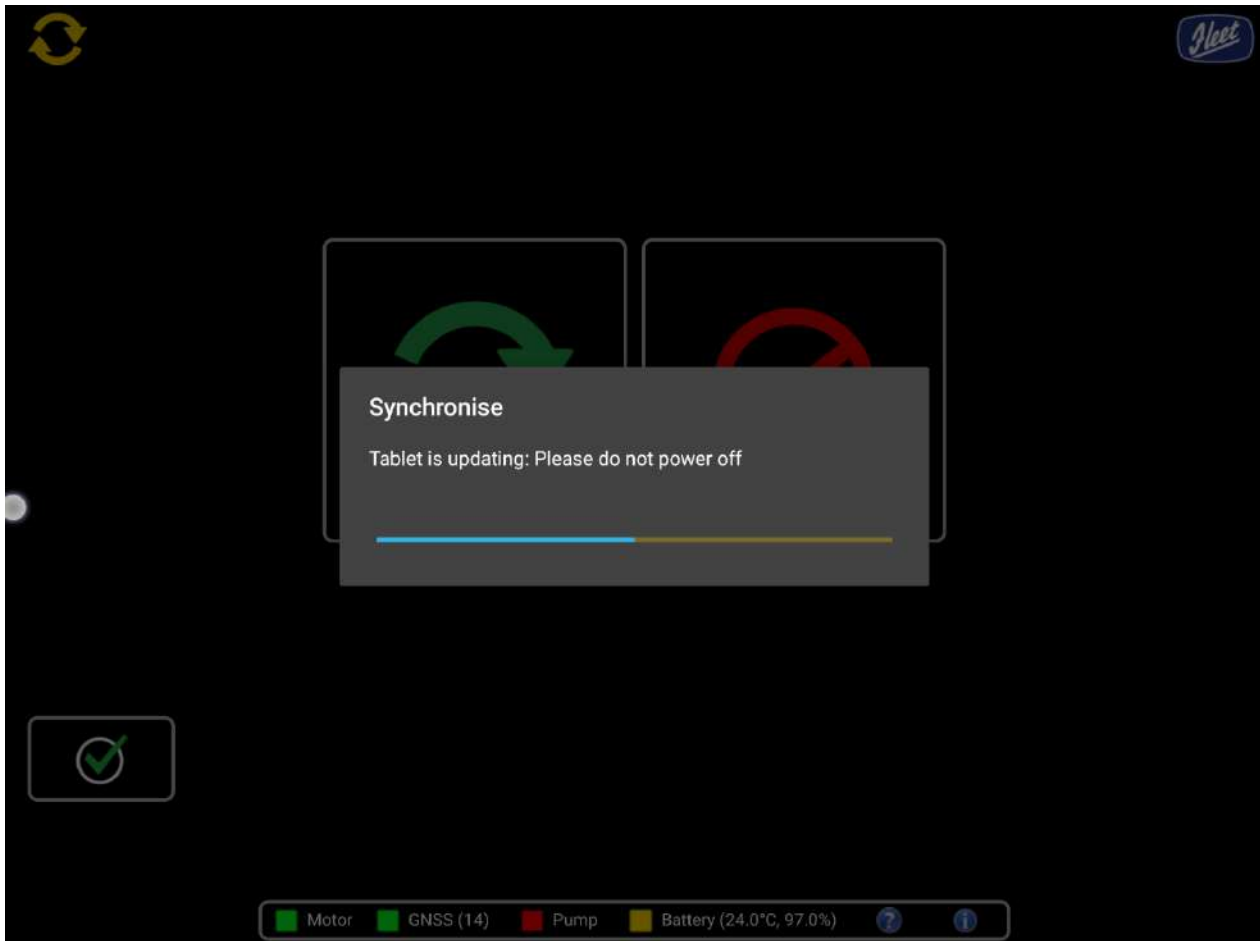

## Installing the MAQA Synchroniser

The following steps are needed to install and update the software version:

1. Log in to the Management System at the following URL: [www.maqamarker.com](http://www.maqamarker.com) This will present the log in screen for the web interface to the Management System as below:



2. Enter the login credentials provided to you by Fleet and then select the Login button.
3. On the main Management System page you will see a grid of icons, as below:



4. Click on the Downloads button, this will bring up the Downloads screen.



5. On the Downloads screen you will need to download the upload tool by clicking the “MAQA Synchroniser” link.
6. Once the utility has been downloaded, run the installer by clicking on it, this will bring up the first stage of the installation wizard.
7. Please read the license agreement and then select the option “I accept the terms in the License Agreement” and click the Next button.

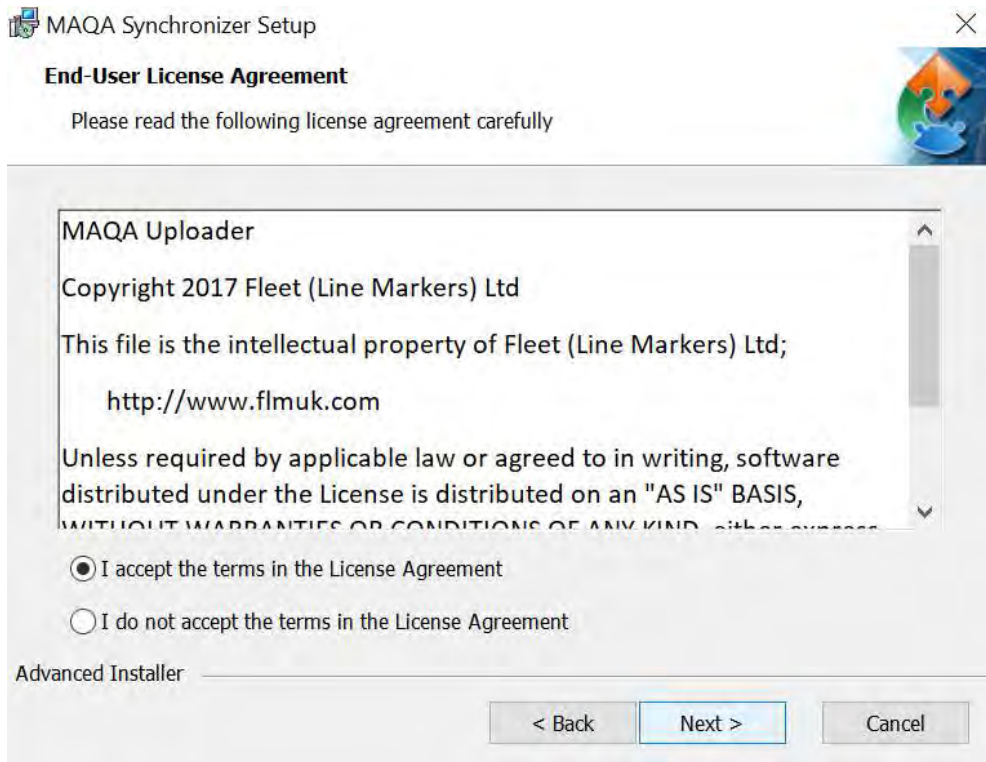

8. On this page select the Next button.

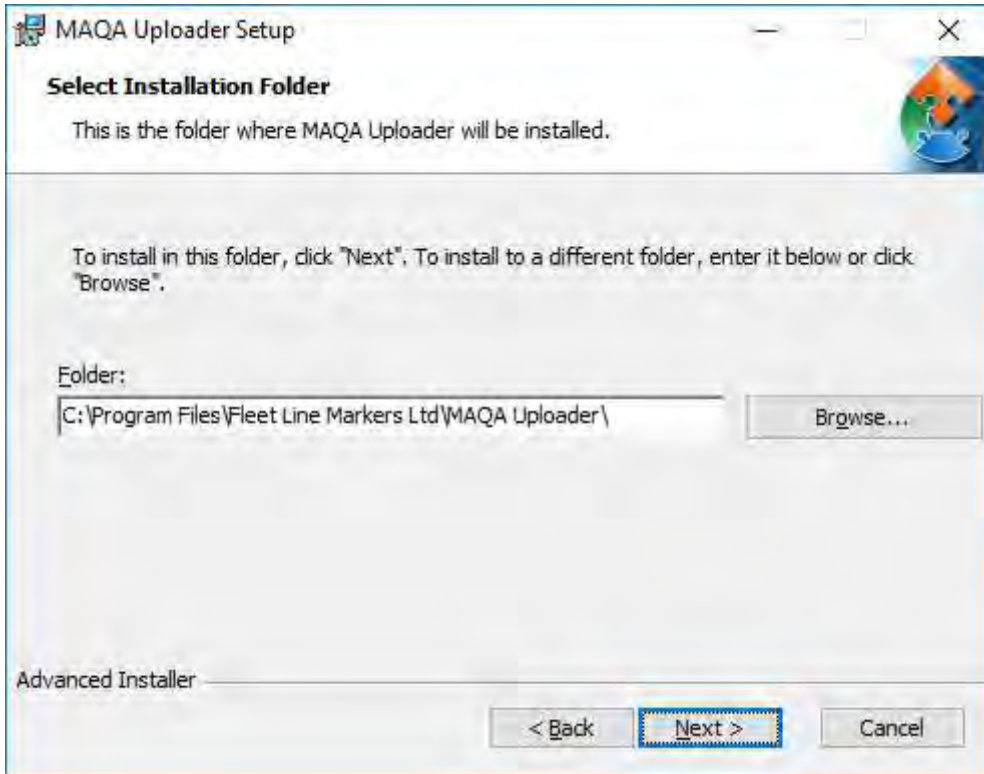

9. On this page you can specify the installation path for the uploader utility, please leave this as default for the moment and click the Next button.



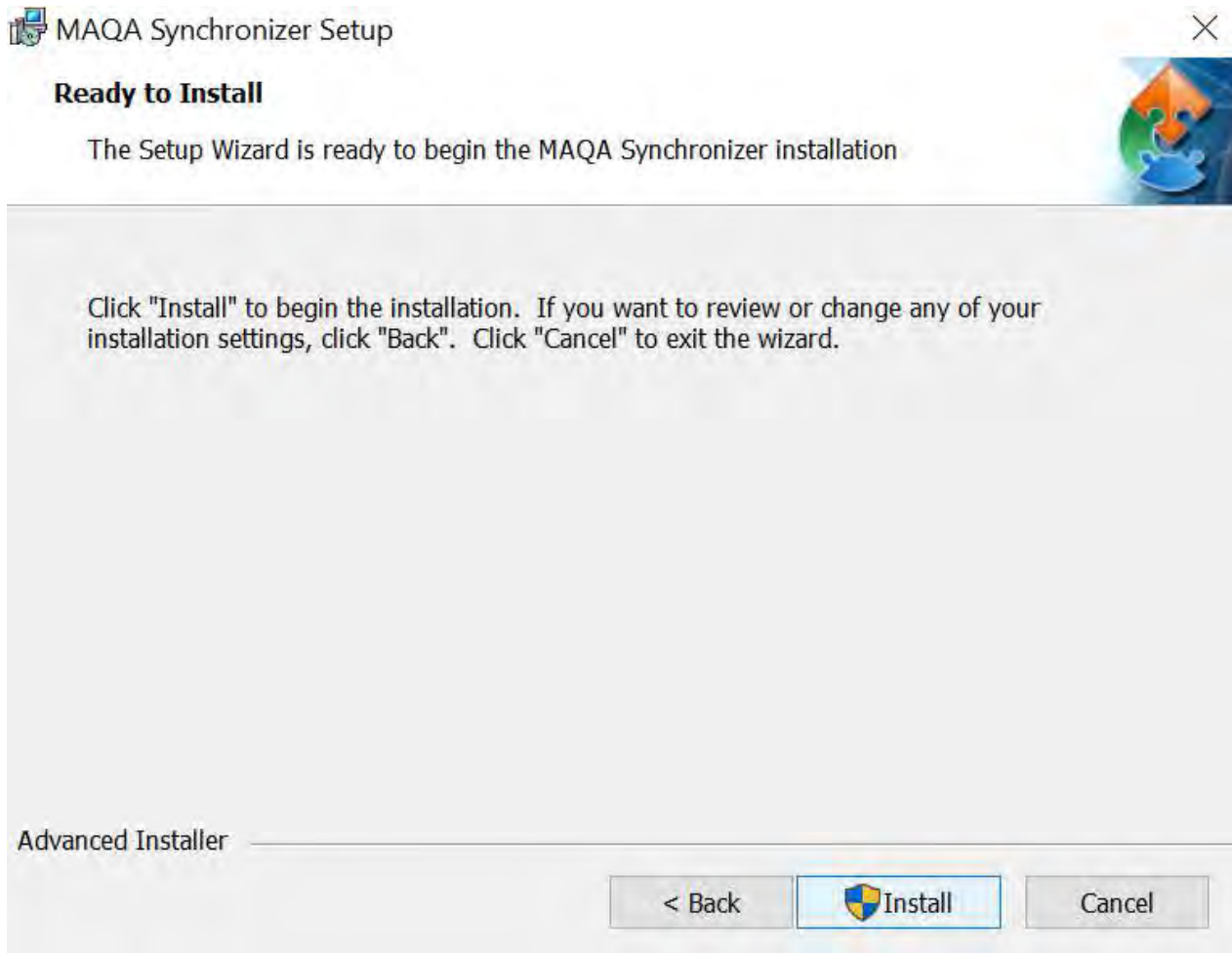

- 10.** On this page please select the Install button – this will prompt you for Administrative credentials if your local user is not an Administrator. If this occurs and you do not know the log in details for an Administrator account, please consult your system administrators.

If you have Windows Defender SmartScreen running you may encounter an additional prompt after step 6 above, where Windows SmartScreen blocks the installation as unsigned:

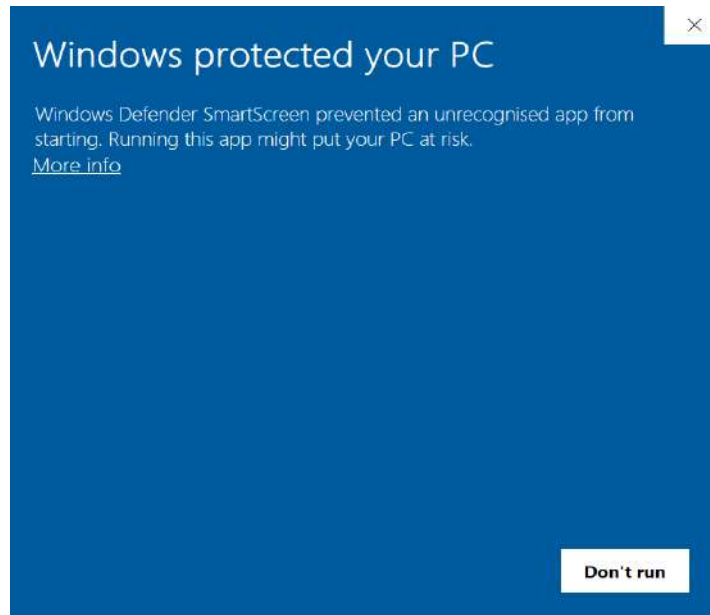

This is a known limitation of the installer package at this time, and to work around this click on the More info link, and then select the Run Anyway option:



### Preparing the tablet for upload

In order for the MAQA data to be uploaded to the system, the MAQA tablet and charging cable will need to be used.



The following steps are needed to prepare the tablet for upload:

1. Ensure that the tablet switch is set to Charge:

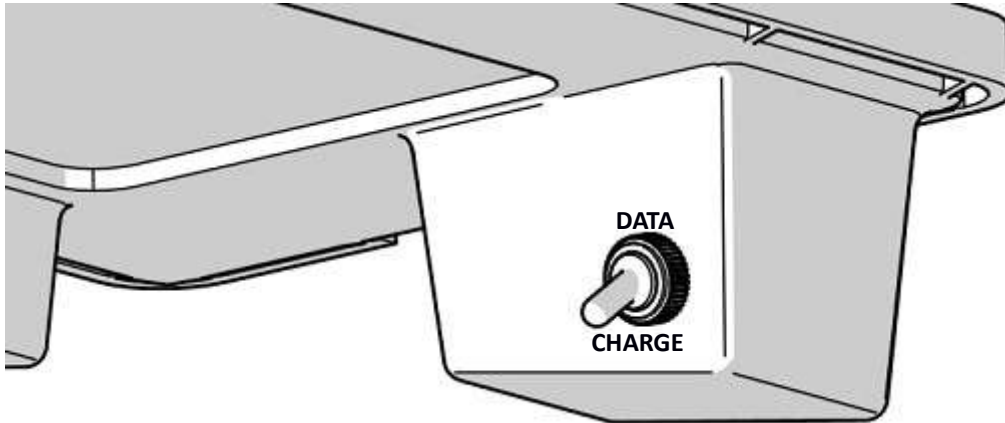

2. If needed, unscrew the water tight cap on the USB connector, and then plug the USB cable into the tablet.
3. Power the tablet on. It is advisable to have at least 50% battery before attempting an upload.
4. When prompted, enter the Tablet Pin code, and then log in using your normal user name and password to get to the tablet home screen.

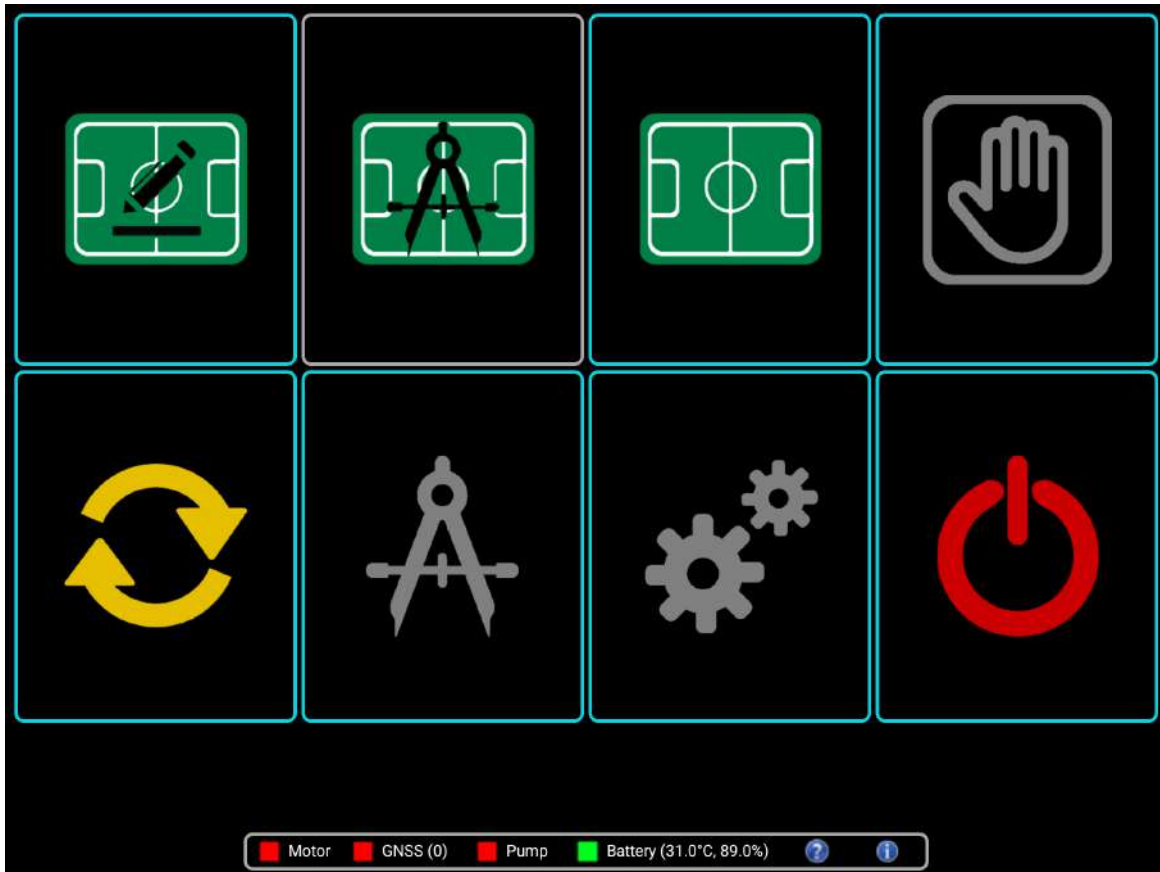

5. When the home screen loads connect the tablet to the computer via the data USB cable provided.
6. As a security precaution the tablet will raise a prompt when the tablet is plugged in asking whether to permit access, ensure the Always permit from this computer option is checked, and then press OK:

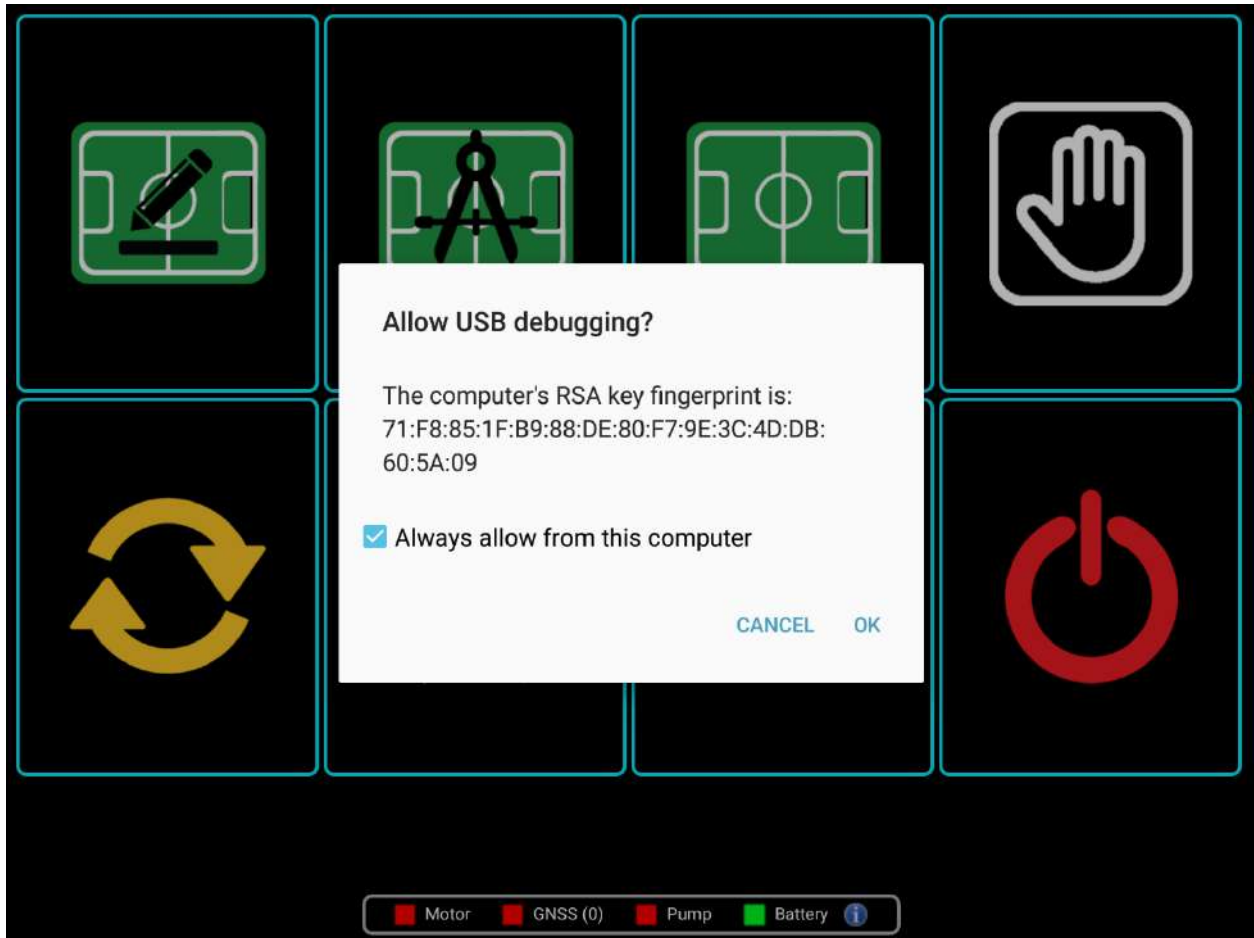

7. This will enable the tablet for uploading data on this specific PC.

## Using the MAQA synchroniser application

Once the MAQA Upload application has been installed and the tablet is prepared to upload, you will then need to perform the following steps to upload the data:

1. Start the MAQA synchroniser software – on installation there should be a desktop icon created, double clicking on this will start the synchroniser application.

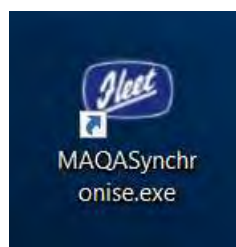

2. Once the MAQA synchroniser software has started up, you will be prompted for the user name and password for the Management System, i.e. the same values entered logging into the Management System web interface.

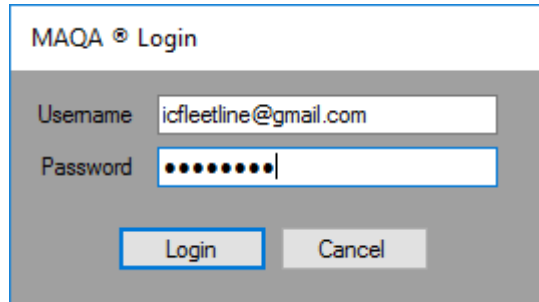

A screenshot of a login dialog box titled "MAQA © Login". It features two input fields: "Username" with the text "icfleetline@gmail.com" and "Password" with masked characters. Below the fields are two buttons: "Login" and "Cancel".

3. This will display the main Uploader form.
4. On the tablet select the Synchronise option from the Home page (the circular arrows to the bottom left of the screen) – this will show the synchronise screen.

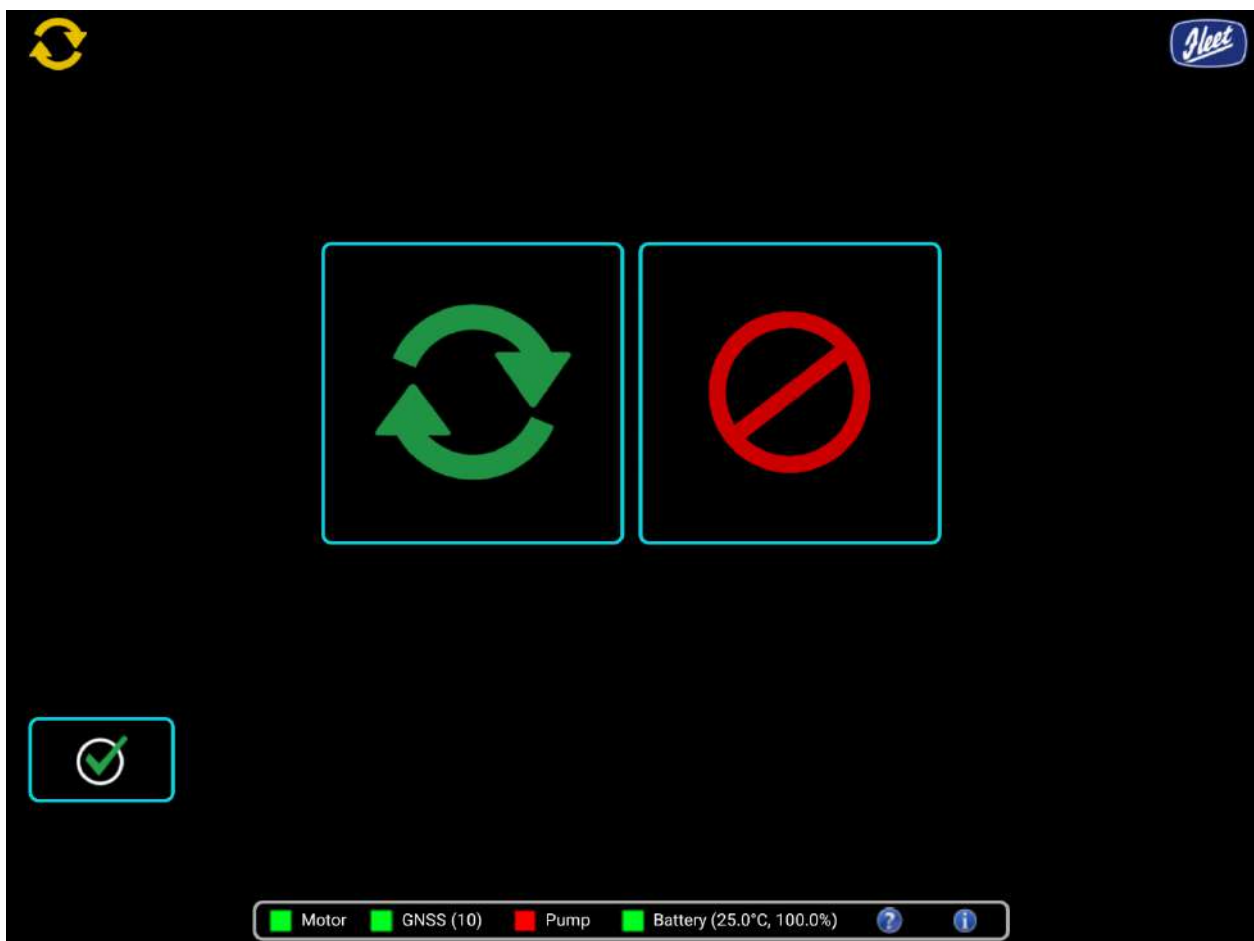

5. Press the green button in the middle of the screen – this will start the tablet sync process and disable all the buttons but the Cancel option:

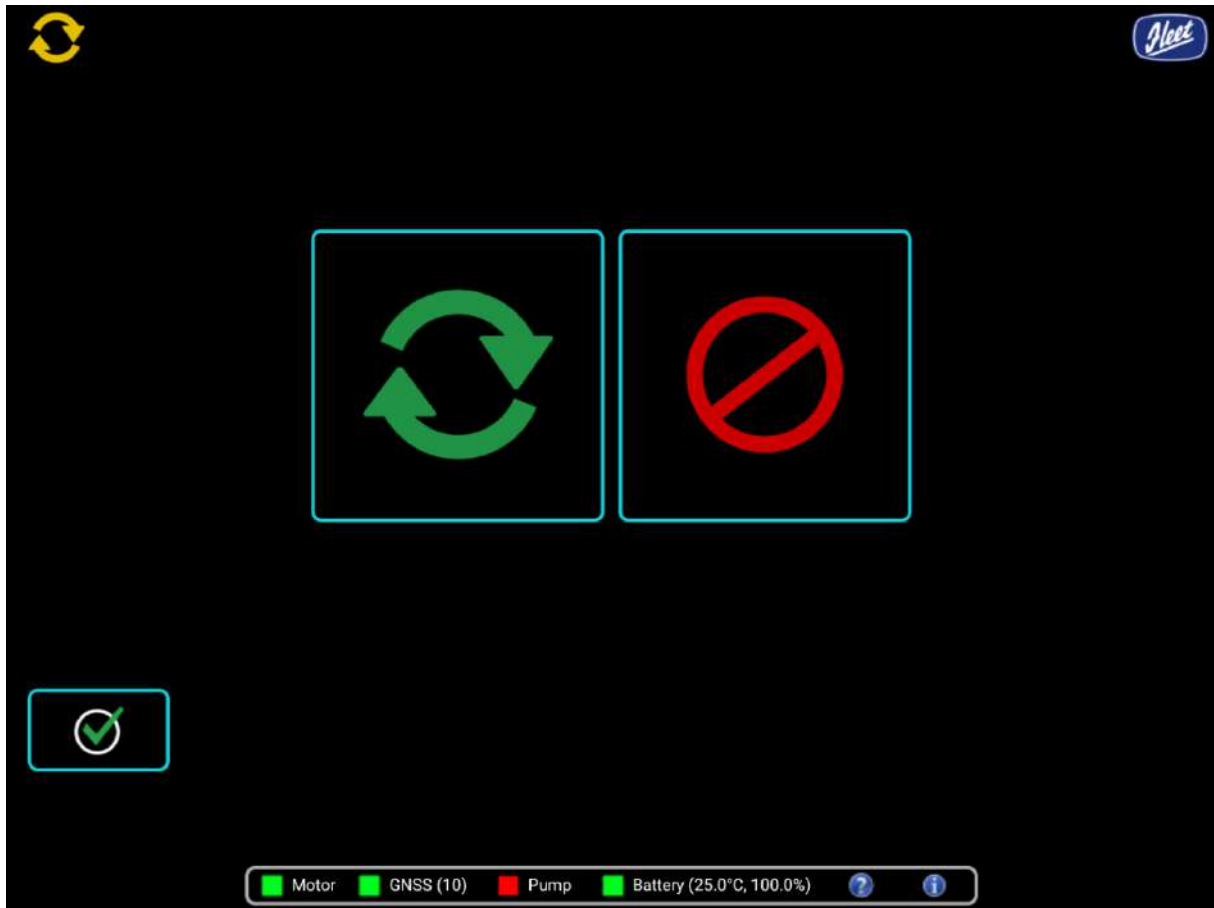

6. Now go to the MAQA synchronise software on the PC and select the Device menu and the Synchronize option:

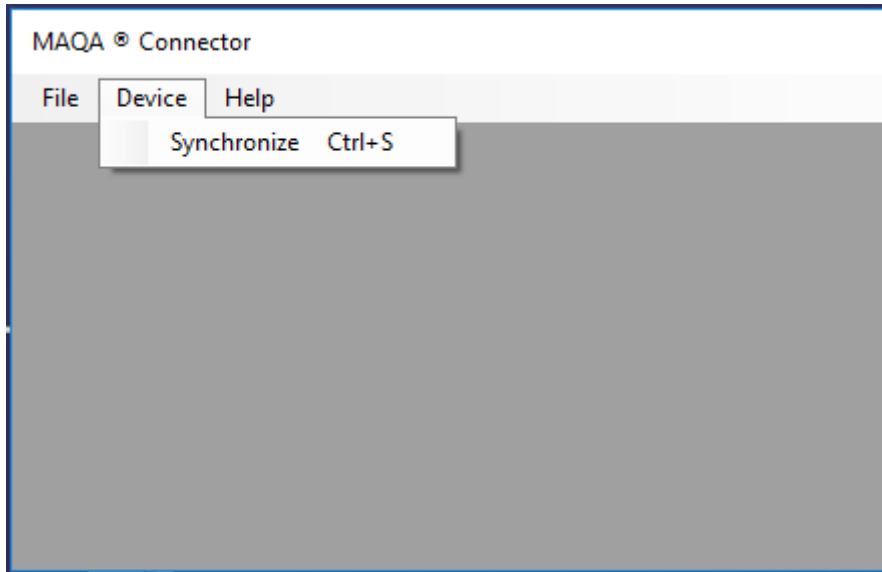

7. This will start the synchronisation process and show a progress bar in the MAQA Uploader software:

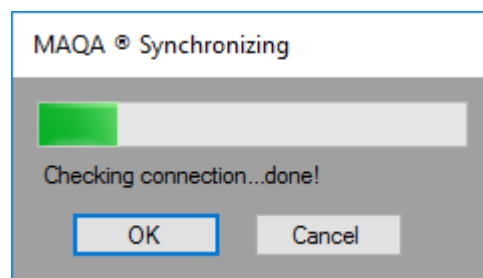

8. If the uploader can connect to the Management Server correctly, the upload will progress over a number of seconds and once it is complete a confirmation dialogue will be displayed:

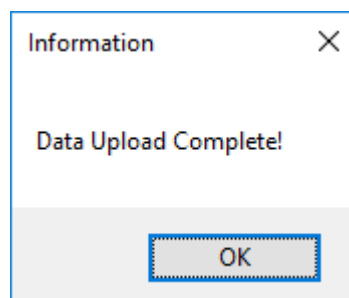

9. Please note that at this point the tablet will still be in the process of updating, this will take several minutes to complete as it unpacks the files from the update. Once the tablet has finished the Synchronise screen will re-enable the OK button:

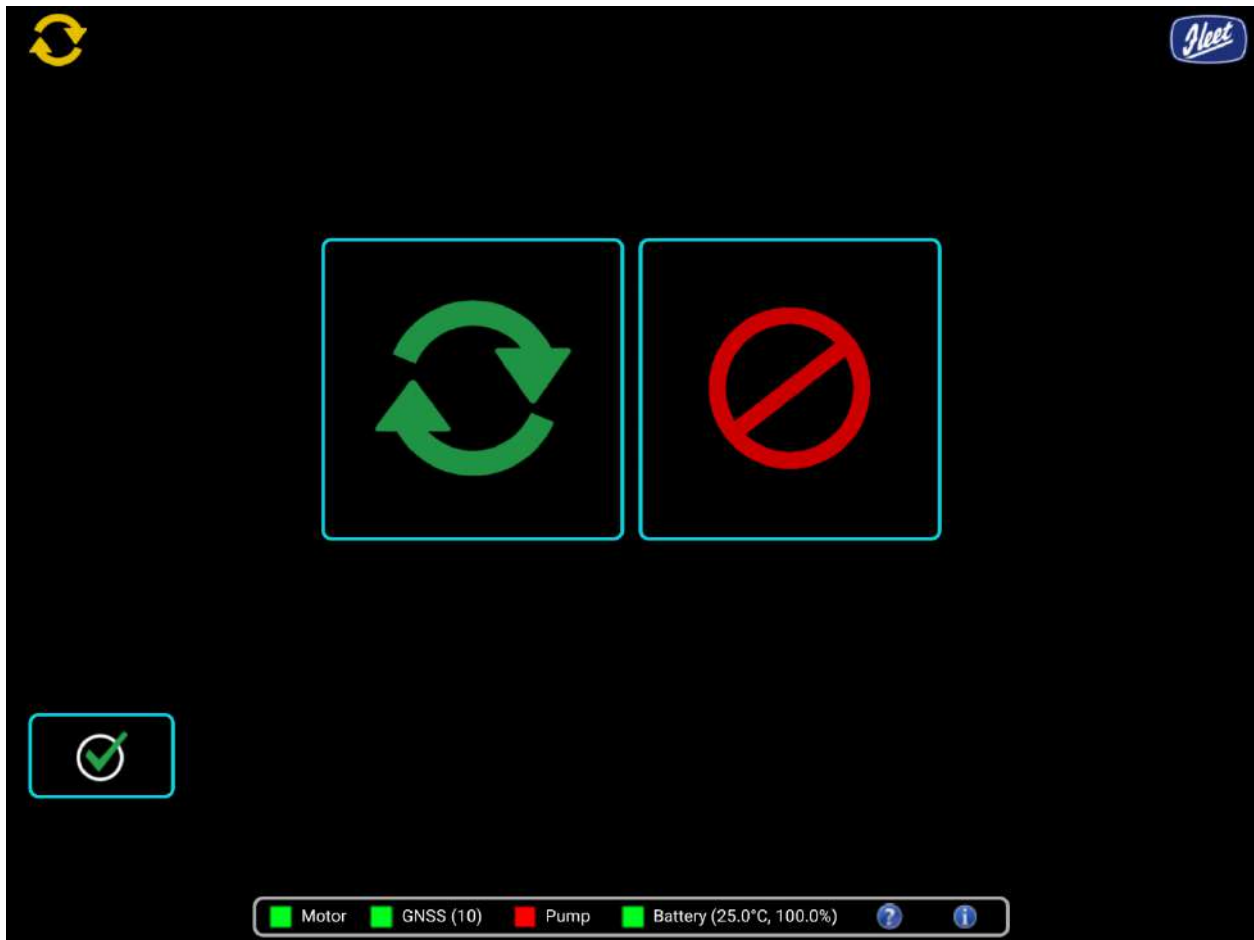

**10.** Once the update has completed on the tablet, please reboot the tablet to complete the installation, and follow the steps to get back to the home screen.

If there are problems during the upload process the tablet upload can be cancelled by hitting the Cancel button on the Synchronise screen, however this should only be undertaken if there is no other choice as this may leave the tablet in an indeterminate state requiring a full reset.

To check the success of the update, please click on the information icon on the home screen, this will show the information for the MAQA software, including software version and days activation remaining:

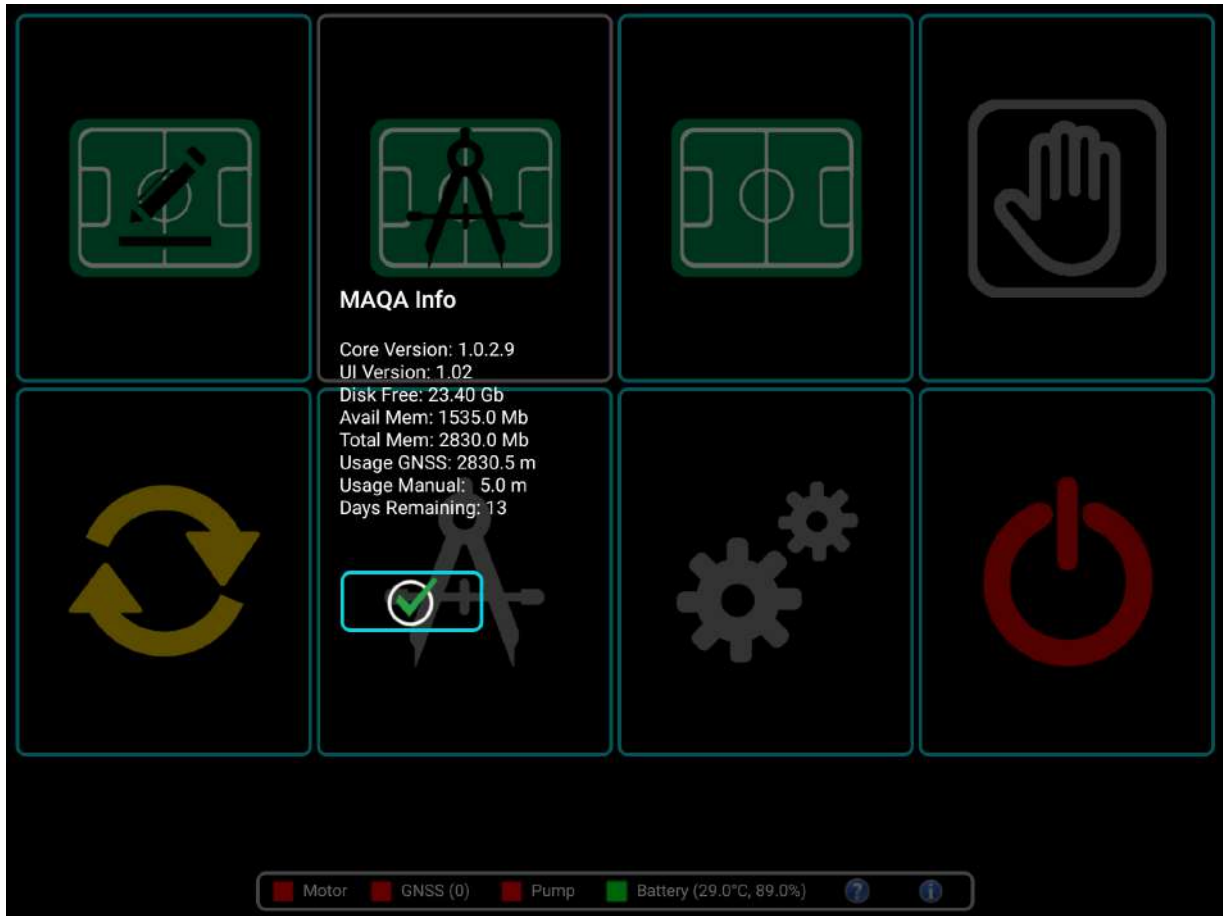





Fleet recommends the following products to keep your Kombi looking like new.

Fleet (Line Markers) Limited Fleet House, Spring Lane, Malvern, Worcestershire, WR14 1AT

Tel: + 44 (0) 1684 573535

[www.fleetlinemarkers.com](http://www.fleetlinemarkers.com)

[sales@flmuk.com](mailto:sales@flmuk.com)